

Noise Analysis and Reduction of a Floor Scrubber

**Team: Arsalan Ahmed, Pratyusha Devarakonda, Bronson Edwards,
Priyanka Sohani**

ME450, FINAL REPORT

Department of Mechanical Engineering

University of Michigan

Ann Arbor, MI 48109-2125

Instructor: Dr. Lalit Patil

Sponsor: Fred Hekman, Tennant Company

April 15th, 2008

Semester: Winter 2008

Team # 36



EXECUTIVE SUMMARY

Commercial floor scrubbers are self-propelled machines operating on batteries. They are designed to clean floors using scrubbers. The vacuum system then recovers dirty water, leaving the floor dry and clean. Although the current technology is an efficient one, operating the machine tends to make a lot of noise. This is undesirable to the operator, and in places like hotels and hospitals where loud sound levels are not preferred. The Tennant Company sells the T5 floor scrubber, operating at 68 A-weighted decibels (dBA), to several different customers.

We were required to redesign the components to decrease the noise level by 3 dBA. Tennant also required that the main components of the scrubber, including the overall size, weight, and capabilities, were not compromised. Furthermore, the redesign could not exceed the bulk manufacturing cost of \$100. Additional volume could not exceed 1 cubic foot (ft³) and operating temperature could not exceed 140 Degrees Fahrenheit (°F). A Quality Function Deployment (QFD) diagram was prepared to better understand customer requirements and deduce engineering specifications to assist in planning for the project. We then performed sound testing and analyzed the main sources of noise, which led us to generate concepts and finalize our concept selection. After further research, we finalized our design and created a fabrication plan for the prototype.

To analyze the sources of noise, we used a handheld device to test the noise level at specific areas outlined in a sound map. We identified the main sources to be the muffler, recovery tank, and midsection of the floor scrubber. We did extensive research on the best materials and geometries for component redesign.

In addition, we performed frequency analysis on the floor scrubber to help us determine high and low frequencies. We tested our α -design, and made appropriate changes to develop our final design. We finalized our new concepts based on mathematical analysis. We also performed cost analysis and created an initial fabrication plan. Our final design consisted of an elbow pipe, expansion muffler, fiberglass insulation, mounts, rubber seal and Active Noise Cancellation (ANC).

We made a prototype for the elbow pipe and the muffler using PVC pipe, since PVC is the material that most closely resembles the recommended material for our final design. The fiberglass insulation wool was locally purchased and installed into the scrubber, whereas the isolation mounts were provided by Tennant Company and installed in the machine. ANC is the only design that was not implemented into the prototype due to lack of time. The total cost of the prototype was \$144.17, including labor and equipment. The same validation procedure was followed as before, and we achieved positive results with noise reduction of 1½ dBA with elbow pipe and 1½ with muffler.

Time constraints of less than four months was challenging but forced us to work efficiently. Earlier frequency testing would have helped us isolate the locations of highest noise. Access to better equipment would have provided us with the most accurate measurements, and may have aided us in generating additional concepts. Ultimately, our designs are effective in sound reduction, easy to manufacture, and successful in minimizing manufacturing costs.

Table of Contents

1. INTRODUCTION	3
1.1 Information Search.....	3
1.2 Sound Absorption Theory in Muffler and Suction Pipe Design.....	3
1.3 Active Noise Cancellation Theory.....	4
1.4 Reactive Mufflers.....	6
1.5 Technical Benchmarks.....	7
1.6 Information gaps.....	8
2. CUSTOMER REQUIREMENTS.....	9
3. ENGINEERING SPECIFICATIONS.....	9
4. QUALITY FUNCTION DEPLOYMENT (QFD) DIAGRAM.....	10
5. SOUND ANALYSIS.....	10
5.1 Sound Testing.....	10
5.2 Noise Flow Diagram.....	13
6. CONCEPT GENERATION.....	14
6.1 Muffler.....	14
6.2 Water Recovery Tank.....	16
6.3 Midsection of Floor Scrubber.....	17
7. CONCEPT SELECTION.....	19
7.1 Muffler.....	19
7.2 Midsection of Floor Scrubber.....	20
7.3 Water Recovery Tank.....	20
8. α DESIGN CONCEPT SELECTION.....	21
9. POST α -DESIGN ANALYSIS.....	22
10. PARAMETER ANALYSIS.....	22
10.1 Muffler Design.....	22
10.2 Active Noise Cancellation.....	24
10.2.1 Lab Testing For Active Noise Cancellation.....	27
10.2.2 A.N.C Approaches and Sampling Rate.....	29
10.3 Rubber Seal.....	30
10.4 Elbow Design.....	31
10.5 Design Analysis Assignment.....	34
11. FINAL DESIGN DESCRIPTION.....	35
11.1 Elbow Pipe Redesign.....	35
11.2 Muffler Redesign.....	37
11.3 Isolator Gaskets.....	38
11.4 Seal.....	39
11.5 Motor Insulation.....	40
11.6 Active Noise Control.....	41
11.6.1 Component Selection and Analysis.....	41
11.7 Final Design Summary.....	44
12. PROTOTYPE AND FABRICATION DESCRIPTION.....	44
12.1 Elbow Pipe Design.....	44

12.2 Muffler Design.....	46
12.3 Motor Insulation.....	47
12.4 Mid-section Seal	47
12.5 Isolation Mounts	48
12.6 Active Noise Equipment.....	48
13. VALIDATION APPROACH	48
13.1 Muffler Design.....	49
13.2 Elbow Pipe	49
13.3 Seal, Isolation Mounts, and Motor Insulation.....	52
14. DISCUSSION	53
15. RECOMMENDATIONS	53
15.1 Re-Manufacturing	54
15.2 Experimental Testing.....	55
15.3 Active Noise Control (ANC)	55
16 SUMMARY AND CONCLUSIONS	55
17. ACKNOWLEDGEMENTS	56
18. REFERENCES	57
19. BIOS	58
20. APPENDIX A	60
20.1 QFD.....	60
20.2 Gantt Chart.....	61
21. APPENDIX B	62
21.1 Motor Fan Cover.....	62
21.2 Muffler Concept Generation	63
21.3 Muffler Engineering Analysis.....	63
21.4 CAD Drawing and Illustrations	65
22. APPENDIX C	68
22.1 Bill of Materials	68
22.2 Process Plan Sheets.....	70
23. APPENDIX D	71
23.1 Description of Engineering Design Changes	71
24. APPENDIX E	75
24.1 Cambridge Engineering Selector (CES).....	75
24.2 Design for Assembly (DFA).....	76
24.3 Material Selection and Design for Environment	79
24.4 Design for Safety	87
24.5 Manufacturing Process Selection.....	89

1. INTRODUCTION

The objective of this project was to analyze the sources of noise in a model T5 floor scrubber provided by our sponsor, Tennant Company. Tennant requested our assistance in the redesign of components to reduce the noise level by at least 3 dBA while the machine operates at optimal level without significantly increasing the production cost. The unit “dBA” refers to the ‘A’ scale of frequency weighting. The unit is weighted in such a way that its sensitivity correlates well with the human ear’s perception of noise.

1.1 Information Search

Our patent search shows that current floor scrubbers attach an acoustical foam sheet to the vacuum system to dampen the noise. Some floor scrubbers use cushion tires, and in some cases, spring caster wheels are used to reduce the noise level when operating on rough surfaces [1]. Yet, these methods are not entirely efficient because of the constraints. The foam sheet size cannot be substantially large because that leads to an increased size of the floor scrubber, and the spring caster wheels are too expensive to be implemented on a floor scrubber.

The patent introduces several new ideas to reduce the noise level of the floor scrubber to a desirable level. Some of the sources of noise are the vacuum system and the motor. Therefore, the patent presents the idea where an elastomeric isolator mount can be placed between the truck and upper assembly. The truck controls the wheels and the drive motor and the upper assembly controls the tank that holds the cleaning solution and the handle that operates the machine. The elastomeric mount can reduce vibrations between the trunk and upper assembly that the current floor scrubbers are experiencing [1].

We completed our information search using the internet and sponsor suggested links, providing us with numerous technical details of the products. The two main competitors of the Tennant T5 are the ‘Minuteman 320’ by Kellermeyer [2] and ‘Warrior ST’ by Advance [3]. These products are similar to each other. They are all equipped with standard features. They are self propelled machines with a vacuum and squeegee attached to the lower end of the scrubber. However they differ in specification details and performance. For further technical details refer to Table 2 for comparison between products.

1.2 Sound Absorption Theory in Muffler and Suction Pipe Design

For our engineering analysis, we realized that one of the most important engineering models is the muffler/suction pipe design. A suction pipe sucks dirt by means of pressure difference between the interior and exterior of the cleaner using air. From our understanding and through literature search, we realize that a significant amount of noise is generated in the suction pipe due to the flow of air entraining the dirt through the pipe. In the muffler, it is due to the high pressure air flowing through it [6]. As a test case we looked at the experimental results of a pipe insulated with Polyvinyl Alcohol Sponge (PVA). The graphs below show the change in Sound Pressure Level (dBA) with respect to change in dimensions [6].

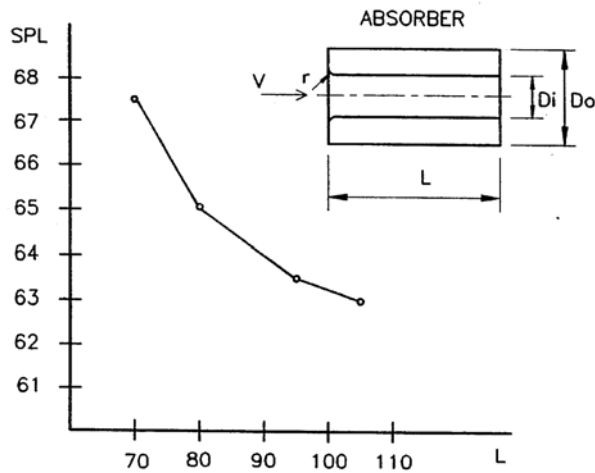

Figure 1 illustrates the change in Sound pressure Level for a change in length of the pipe at constant thickness [6]

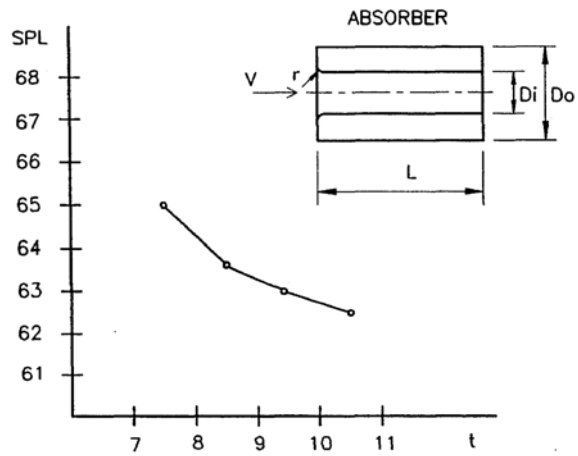

Figure 2 illustrates the change in in Sound pressure level for change in thickness at constant pipe length.[6]

In the above schematic L (mm) is the length of the pipe, D_i & D_o are the internal and external diameters respectively and t (mm) is the thickness of PVA. The standard velocity measured is 58 m/sec. Figure 1 shows that longer sound absorbing material lowers the noise level for constant thickness. Figure 2 shows that thicker absorbing material lowers the noise level for constant length. Change in pipe orientation also helps in reducing the noise significantly; for instance, bending the muffler 90° attenuates noise because sound would have to travel around corners thus dissipating energy.

Varying the diameter of the muffler along the length is an important concept in noise reduction. The ratio of the cross-sectional areas of the muffler determines the range of sound frequency that is passed through the muffler. By selecting appropriate dimensions, high frequency noises can be reduced [7]. More experimental work needs to be performed to test the feasibility of this concept.

1.3 Active Noise Cancellation Theory

To understand the effectiveness of this technology, we looked into the performance results of ANC device by 'Technofirst' [11]. A sample test was performed on an 80mm computer cooling fan with four speakers and microphones installed at each corner.



Figure 3: illustrate a Computer Fan installed with speakers and microphones.

After performing the test, the following sound energy results were obtained around the fan.

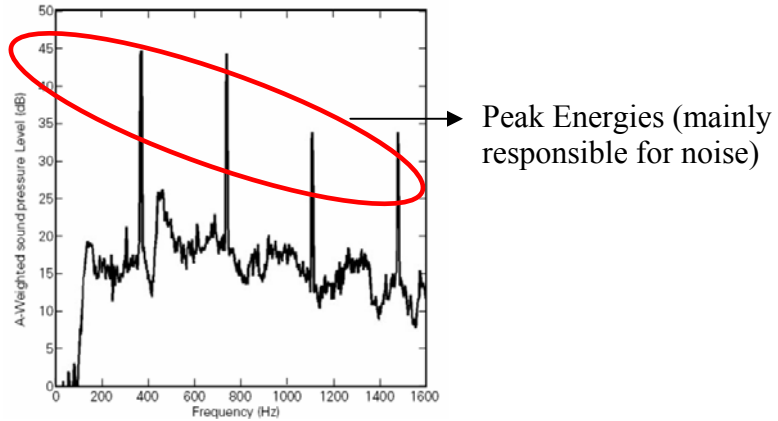

Figure 4 illustrates the frequency spectrum for the Computer Fan

After installing ANC, the noise levels were reduced at these peaks in the range of 8-10 dB. The table below demonstrates the mean-square pressure reduction (MPR) in dB.

Number of Speakers	370 Hz	740 Hz	1110 Hz	1480 Hz
	MPR	MPR	MPR	MPR
3	9.5	15.7	11.8	8.9
4	10.1	15.3	12.8	8.7

Table 1 lists the sound level reduction at various frequencies

From the above results we observe that ANC is an effective solution. It also depends on the number of speakers that are being installed. The more the speakers the more noise control can be obtained. However symmetrical arranged of speakers should be maintained for optimal control [12]. Since noise level changes frequently, the microphone needs to actively detect sound. Microphone selection is based on its center frequency f_c is proportional to the Number of fan blades and the fan speed (cycles/sec):

$$f_c = N_{blades} * Speed_{fan} \quad (\text{Eq 1})$$

Another major source of noise is the recovery tank. Due to the hollowness and large volume, it is susceptible to reverberation thus producing high noise level. ANC approach in enclosed spaces is a little different than what was mentioned above, mainly due to the random nature of noise. The microphone is equally likely to be struck by a sound wave from any given direction; sound

waves are running amuck in enclosed space [10]. Active noise control can provide optimal results such that the equipment is in a way that would cause the most destructive interference.

Another Technology of Technofirst called the ‘Cabin Noise Reduction Technology’ deals with noise reduction for enclosed spaces [11]. This technology was implemented in diesel engine, reducing sound peaks at 45, 125 and 210 Hz, leading to an overall decrease of about 15 dB.

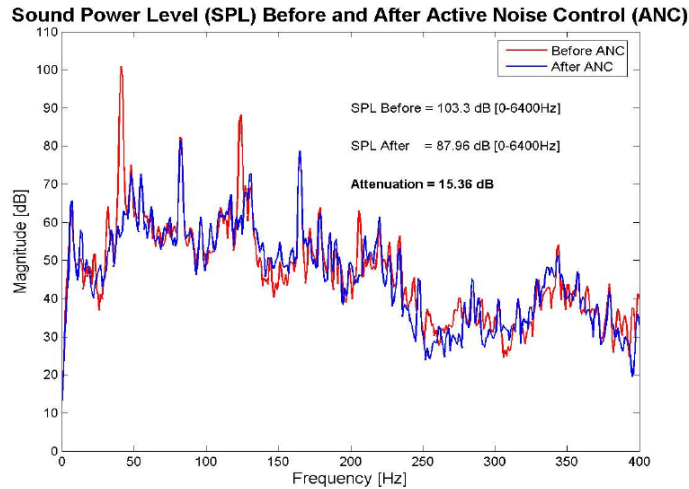

Figure 5 illustrates the frequency spectrum for the diesel engine.

Active noise cancellation has proven to be useful noise reducing tool, with easy replacement, affordability, compactness. The same technology can be made even more effective by installing more speakers and microphones at different locations for more noise filtering.

1.4 Reactive Mufflers

Reactive mufflers help to reduce noise through destructive interference. This is when two waves pass and the shape of the medium is affected by the amplitudes of the waves.

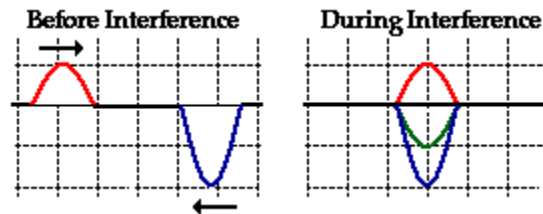

Figure 6 shows the concept of destructive interference [19]

The figure below shows a basic design of a reactive muffler with an expansion chamber. The different portions of the muffler are labeled accordingly. When sound waves travel through the muffler, reflections will occur in the expansion chamber causing destructive interference [20]. Noise will then be reduced through this process.

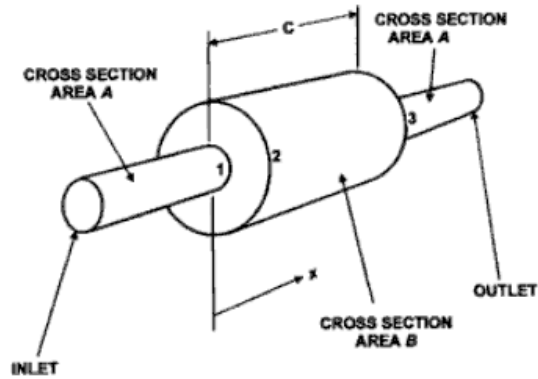

FIGURE 14.19. Expansion chamber of a reactive muffler.

Figure 7 shows a reactive muffler with an expansion chamber [20]

1.5 Technical Benchmarks

There were a large variety of floor scrubbers, but we restricted our search to products with similar physical features. By performing a thorough analysis using the QFD diagram we were able to determine some of the most important technical benchmarks which include (in order of most important to least important):

- Noise level of the floor scrubber
- Retail price
- Machine operating temperature
- Additional volume capacity

Some of the other technical benchmarks that are useful in determining the overall performance of the floor scrubber include the electrical & motor specifications as well as cleaning productivity. These would help us in designing a more robust product keeping in mind the cost constraint that has been set forth for our project.

	T5	Adv Warrior	Minute Man
Engineering Specifications			
Volume	32.44 ft ³	48.85 ft ³	51.65 ft ³
Retail Price	\$10,000	\$9,595	\$ 8,460
Vacuum Motor Power	0.85 hp, 3 stage	0.75 hp, 3 stage	3 stage, 36V, 1 hp
Operating Speed	0-2.5mph	0-3mph	0-2.44 mph
Productivity	35200 ft ² /hr	42240 ft ² /hr	34000 ft ² /hr
Cleaning Time	5.5 hrs	4.5 hrs	Not available
Solution Recovery Tank	22.5/27 gallon	30/30 gal	26/26 gal
Battery	4- 6V/ 235Ah	6-6V	6- 6V/ 220 or 275 Ah
Warranty (tanks/ parts)	10 years/ 3 years	6 years/ 4 years	7 years / 3 years
Tank Construction	Rotational molded polyethylene	Rotational molded polyethylene	Rotational molded polyethylene
Weight w/ batt	621 lbs	914 lbs	921 lbs
Sound level	68dBA	71dBA	72dBA

Table 2 lists all the technical specifications of the T5 and its competitors for comparison purpose.

1.6 Information gaps

One of the biggest challenges the floor scrubber industry faces is minimizing noise level. Until the sound level has reached under 60 dBA some customers are likely to say that “this machine is too noisy” [4]. Through our patent search we were able to determine that the major source of noise is the vacuum system which includes the motor driving the fan [1]. Although replacement of the motor is a possible option, due to cost constraints, such an option may not be feasible. However, we plan investigate other alternatives to reduce noise level. This patent suggests that noise level can be reduced by using acoustical foam sheets and even re-dimensioning the piping lines connecting the vacuum with the air container inside the machine [1].

2. CUSTOMER REQUIREMENTS

An interview with our sponsor helped us to understand the details of the project more clearly. Some of the most important requirements are lowering noise level and reducing overall production cost. Additionally, the T5 should maintain the current operating temperature without compromising the life span of the floor scrubber. Other desirable requirements include maintaining the overall water tank for optimal cleaning, and maintaining the durability of the floor scrubber. The Engineering specifications are shown below in Table 3. The Quality Function Deployment (QFD) matrix can be found in Appendix A. QFD diagram helps in understanding the relation between customer requirements with its corresponding engineering specifications.

3. ENGINEERING SPECIFICATIONS

We developed our engineering specifications using the customer requirements of our project sponsor and Tennant representative Mr. Fred Hekman. After meeting with Mr. Hekman, consulting amongst our team, and some literature research, we were able to quantify our design specifications in order to make this project achievable. The complete list of customer and engineering specifications is listed below in Table 3.

Customer Requirements	Engineering Specifications	Physical Quantity
Durability	Additional Max. Weight	20 lbs
lower noise level*	Additional Volume*	1.0 ft ³
easily replaceable	Operating Temperature*	140 °F
want to optimize water tank size	Sound level reduction*	3 dBA
maintain overall scrubber size	Life Span	1500-2000 hrs
must be light weight	Vacuum Motor Power	0.75 hp
plastic material	Cart Speed	2.5mph
ergonomics/aesthetics	Productivity	35,200 ft ² /hr
long life span	Manufacturing Time	1.2 hrs/machine
bulk production	Retail Price*	10,000
Affordable*		
controlled operating temperature		
Self Propelled		

Table 3 lists the essential customer requirements and the necessary engineering specifications to meet our design goals. Requirements and specifications marked with ‘’ are the most important.*

Based on the customer requirements and product brochure for the T5 [4], we were able to quantify the design specifications relevant to our project research. In order for our component to be durable we need to ensure that we do not exceed 20lbs of the overall weight of the machine within a specified additional volume of 1.0 ft³. We quantified the weight and volume based on the comfort level of the operator. A compact, light scrubber would be easier to operate. At the same time, we cannot reduce the thickness of the tank because the high powered vacuum system would create suction of the scrubber walls resulting in failure. The machine operates at a maximum temperature of 140°F with a life span of 1500-2000 operation hours. The temperature is an important quantity because it affects the durability of the product. If the temperature was

higher, the polyethylene would not be able to handle 1500-2000 operation hours.

We have also been instructed to reduce noise level below 65 dBA, while limiting additional production cost to \$100. Some engineering specifications are more important than others and these are marked with '*' on the QFD diagram.

4. QUALITY FUNCTION DEPLOYMENT (QFD) DIAGRAM

The QFD diagram is used to understand the relationship between the customer requirements and the engineering specifications. These relationships are quantified using values such as 1-3-9 where 1 indicates a weak relation, 9 indicates a strong relation and a 'blank' means there is no relation between the engineering specification and customer requirement. The same numeric rating is designated for the cross correlation matrix which is a comparison between two engineering specifications, how they influence each other. The benchmark evaluation simply compares our product with its competitors. By giving a rating of 1 through 5 where 1 signifies poor and 5 signifies excellent for each customer requirement that the competitor product fulfills.

5. SOUND ANALYSIS

One of the most important tasks of our project was to perform sound testing for the floor scrubber and identify the main source/s of noise. This is particularly important since it would help us in building an optimal design and selecting appropriate material to meet our project goal of sound reduction.

5.1 Sound Testing

Before we performed our sound tests, we decided to adopt a systematic approach to noise control. A typical approach to the problem is illustrated in the flow diagram below in Figure 4. Although this may seem too simple, it does help in understanding how a complex problem can be dealt with.

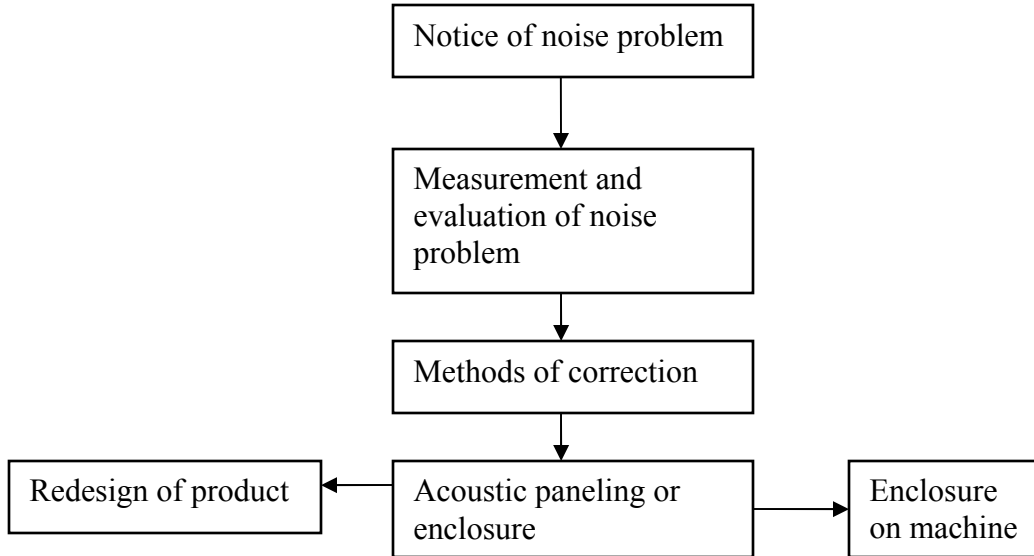

Figure 8 illustrates the steps for noise control [5]

The above approach is only an approximate approach. A lot of other tasks have to be performed before we can design a new component.

To perform our tests we had to place the floor scrubber in a quiet room and disconnect the drive axle while we run the machine so that the scrubber remains stationary during tests. With the aid of sound measuring device, Digital Sound measuring device by Radio Shack, we were able to make all the sound measurements. The baseline sound level of the room we found to be was 55 dBA. The test was performed at different locations around the machine with up to three trials recording both the minimum and maximum sound level. Table 4 summarizes the sound results that we obtained.

Position (All measurements are in dBA)	Trial 1		Trial 2		Trial 3		AVERAGE
	min	max	min	max	min	max	
Operator Ear (w/o scrubber)	67	69	66	68	66	68	67.33
Operator Ear (w/ scrubber)	68	71	68	69	68	69	68.83
Floor scrubber	78	79	78	80	79	80	79.00
side body	76	77	77	78	77	78	77.17
motor fan (inside) w/exhaust pipe	102	103	103	104	102	103	102.83
operator Ear w/o motor w/scrubber	63	65	64	66	62	64	64.00
full operation w/o fan cover w/o scrubber	68	69	68	72	68	69	69.00
full operation w/o fan cover w/scrubber	71	72	71	73	70	73	71.67
full operation w/o fan cover no exhaust pipe	73	75	74	75	73	74	74.00

Table 4 shows the experimental results obtained from the floor scrubber.

From the above data we observe that our sound level is consistent with the nominal value provided by the manufacturer $\approx 67.33-68.83$ dBA [4]. We also observed that the motor fan is responsible for the highest noise in the machine, alongside with the scrubber and the side body. To further study the sound behavior of machine we decided to take measurements on the exterior of our floor scrubber body in order to determine where the most noise is escaping from. A sound

map of the exterior of the floor scrubber is used to indicate the noise level around different positions of the floor scrubber.

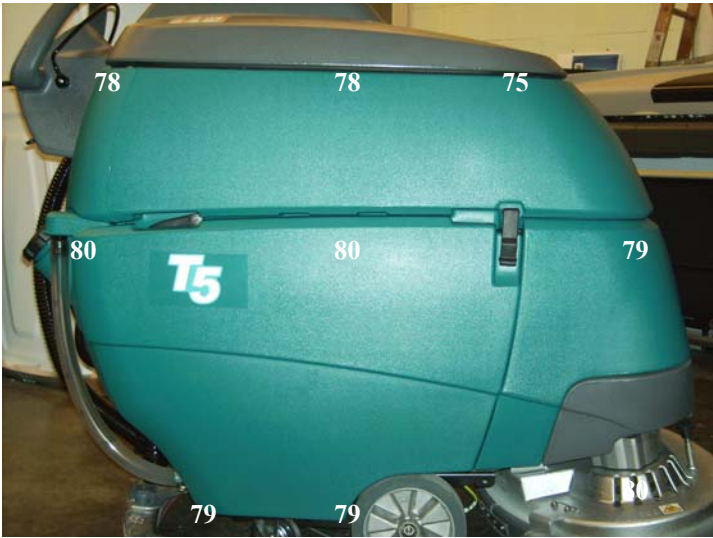

Figure 9 shows a Sound Map of the Right side of the floor scrubber with noise level in dBA.

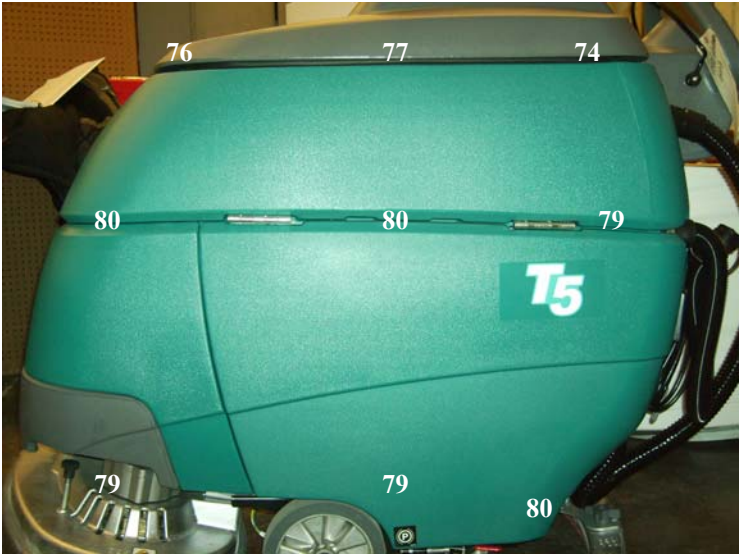

Figure 10 shows a Sound Map of the Left side of the floor scrubber with noise level in dBA.



Figure 11 shows a Sound Map of the Front and Top of the floor scrubber with noise level in dBA.

From the above results, we observed that on the exterior of the floor scrubber, significant amount of noise escapes from the midsection of the side body. Noise levels are also high near the top of the recovery tank.

5.2 Noise Flow Diagram

After sound measurements, it was essential for us to construct a *noise flow diagram*. The purpose of this diagram is to identify the paths along which the sound can travel from the source to air and then to the receiver [5]. It helps in developing design concepts that would reduce noise traveling through such mediums. Once all the paths are identified, it will provide us with direction for the noise control procedure. Damping and eliminating these paths would assist in

reducing the noise.

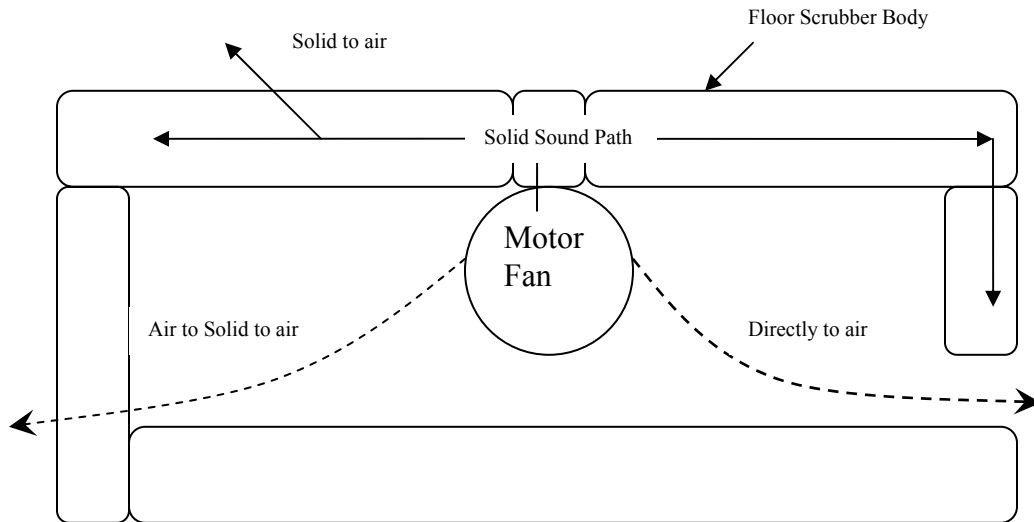

Figure 12 illustrates the noise flow diagram of the floor scrubber indicating the path sound takes to escape the floor scrubber.

Based on the sound testing and identifying the path of the sound, we decided to generate our design concepts.

6. CONCEPT GENERATION

After performing our sound testing, we narrowed down the sources of sound to the muffler on the motor, recovery tank, and the escape of noise from the midsection of the floor scrubber. Since these three sources are independent of each other, we generated concepts for each component separately.

We initially also generated concepts for a fan cover on the vacuum motor. These concepts were determined to be infeasible because the function of the fan is to circulate air flow and cool off the vacuum motor. Since a fan cover would be limiting the air flow, it could compromise the efficiency of the motor. Because of this reason, we chose not to continue with this concept. Details of this concept generation can be found in Appendix A.

6.1 Muffler

Figure 8 below shows the *Problem decomposition* for the motor muffler. The sub-function “Absorbed through geometry” refers to the overall shape of the muffler. For example, the current muffler is simply a cylinder with a constant diameter.

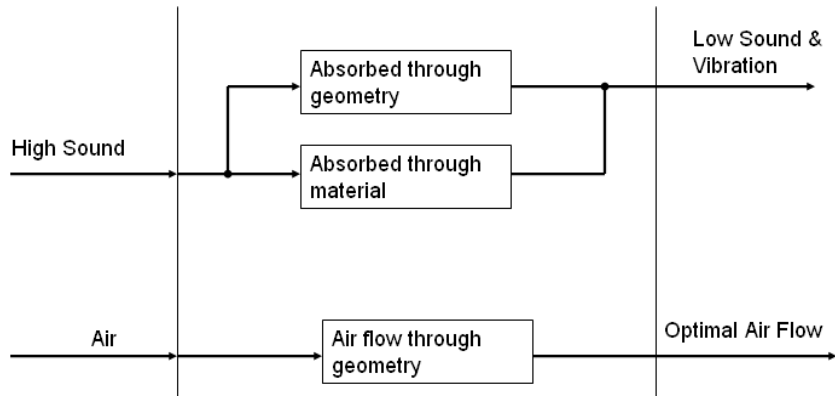

Figure 13 illustrates the Problem Decomposition of Muffler

We then generated concepts for each sub-function which was displayed in a *Concept Chart*. This chart is shown in Table 5. To generate a full concept, we determined every possible combination of sub-function concepts. The full list is given in Appendix A.







Sub function	Sub function Concepts			
Absorb through geometry	 Varying internal diameter	Increase length 	Decrease length 	Change the direction of the flow (S-shape) 
Absorb through material	 Polyvinyl foam	 Natural cotton fiber acoustic insulation	 Mineral fiber	 Fiberglass Insulation batting

Table 5 shows all the possible design features for the Muffler in a *Concept Chart*

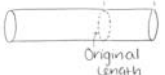
We chose two concepts from the full list that we felt would be the most effective in reducing sound. We will be testing these two concepts on the floor scrubber in the future.

Concept 1: Our research and patent search shows that varying the diameter of the muffler may help to attenuate sound. Figures 10 & 11 below show a sketch and a CAD model of our concept. The sketch is simply an exaggerated form of our concept; the CAD model illustrates the idea more realistically. The ratio of the diameters is directly proportional to the frequency of the sound escaping through the muffler. Further sound testing will help us determine the exact diameters of the muffler. We would most likely use polyvinyl foam, which is the same material that the muffler is currently made of.

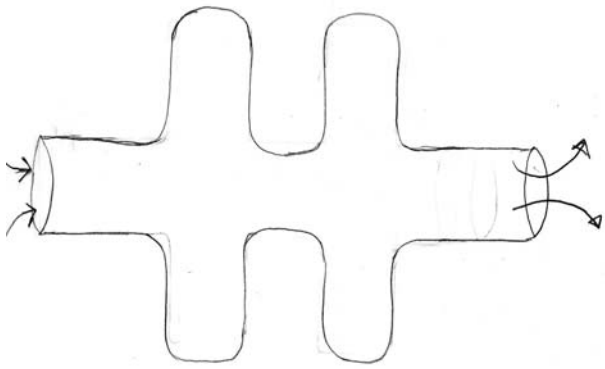

Figure 14 illustrates a Sketch model of Muffler with varying diameter

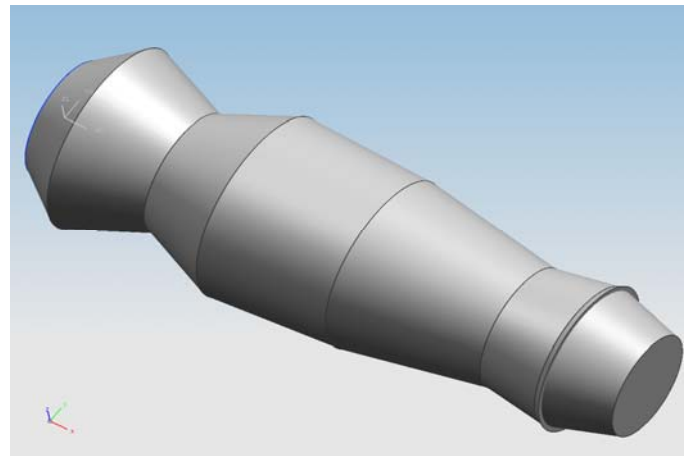

Figure 15 illustrates the CAD model of Muffler with varying diameter

Concept 2: Since a direct line from the noise source to the listener's ear would give the most sound, we believe changing the direction of the air flow can reduce noise. We would like to change the muffler from a straight path to an 'S' shape. Polyvinyl foam will be used for this application as well. Figure 13 below shows a CAD model to depict a clear understanding of our concept. We took the original muffler design and varied its shape. For comparison purposes, we have also shown the original muffler design.

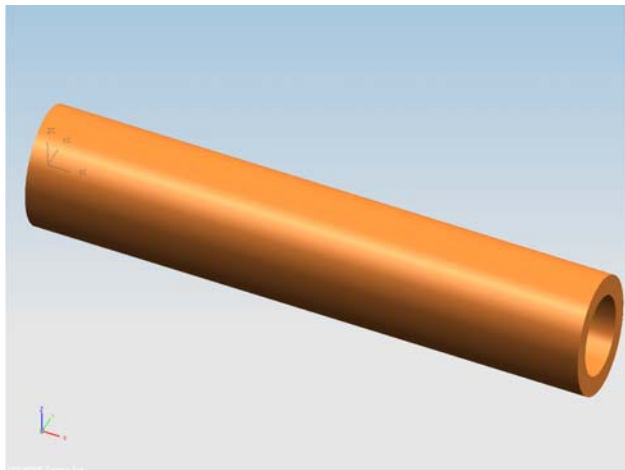

Figure 16 illustrate the original Muffler Design

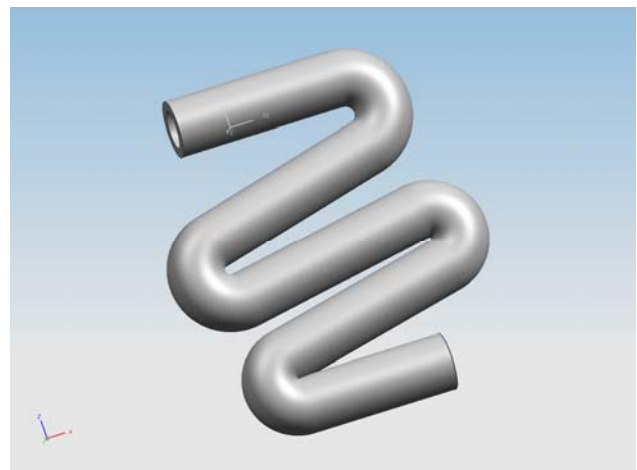

Figure 17 illustrates the 'S' shaped Muffler design

6.2 Water Recovery Tank

Based on our sound testing and research, we determined that the inlet and outlet of the vacuum motor are a major source of noise. As explained in the previous section, we made problem decomposition and generated a concept chart to create concepts. Figure 14 below shows the problem decomposition.

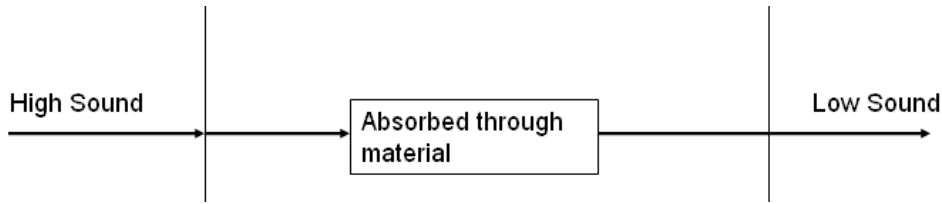

Figure 18 illustrates the Problem Decomposition of Water Recovery Tank

Because the inlet of the vacuum motor is placed in the recovery tank of the floor scrubber, we are interested in lining the inside of the recovery tank with a material that will dampen sound and is also waterproof. Table 6 is our concept chart that shows a few materials we feel will reduce sound.



Sub function	Sub function Concepts	
Absorb through material	 VBD 10 Compound	 Spray on foam

Table 6 shows the possible design features for the Recovery tank in Concept chart

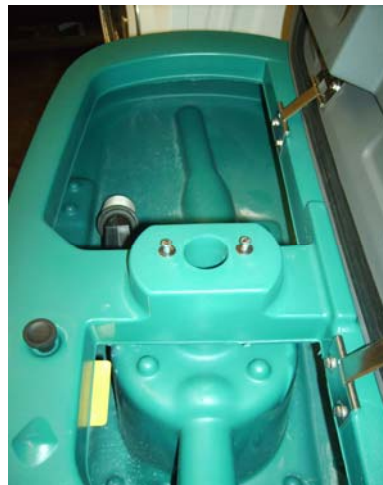

Figure 19 illustrates the recovery tank, which will be sound insulated using foam spray

Since there is only one sub-function of the recovery tank, our final concepts are the same as given in the chart. The material that we will pursue testing is the spray on foam, which is designed to be both waterproof and reduce sound. From a retailer source it was found that VBD-10's performance in water was rated as 'Fair'. Although there will be no actual degradation, there will be some swelling or softening of the material [8].

6.3 Midsection of Floor Scrubber

Our testing showed that there was a lot of sound escaping from the midsection of the floor scrubber. Space was intentionally left between the top and bottom half of the scrubber to ensure

that there was enough air flow so the vacuum motor doesn't overheat. We are interested in limiting the space between the two halves. Figure 15 shows our Problem decomposition.

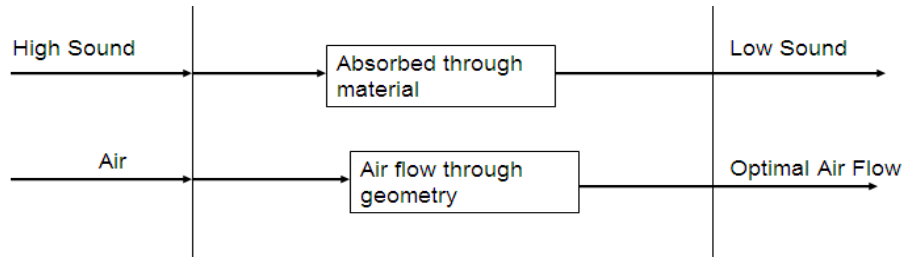

Figure 20 illustrates the Problem Decomposition of Midsection of Floor Scrubber

Table 7 shows the concept chart we used to generate concepts. Appendix A gives a detailed list of our concept generation.



Sub function	Sub function Concepts			
Absorb through material	 Rubber (butyl)	 Cork	 Polyvinyl foam	 Polyurethane Elastomeric Open cell foam
Allow air flow	Partial seal (3/4)			

Table 7 shows all the possible design features for the mid-section in a Concept chart

We would like to place a seal around the midsection of the scrubber to decrease the sound. It is important to make sure that the seal does not block all air flow through the machine because this could compromise the lifespan of the floor scrubber. In order to ensure air flow, we would like to place a partial seal made of rubber around the midsection.

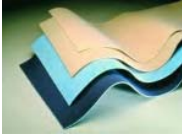

Figure 21 illustrates the Midsection of Floor Scrubber

Figure 17 above shows the midsection of the floor scrubber. The yellow lining indicates the entire region around which the rubber seal can be applied. Along the yellow lining there are certain pockets molded in the body of the scrubber leaving gap for the air to escape. When testing, we will ensure that we leave these gaps unaltered. Covering these gaps may restrict the air flow and overheat the inner components thus affecting the efficiency of the machine.

Figure 18 below gives a summary of the different sources of sound and concepts that we are interested in pursuing. Since the sources of noise are independent of each other, we can also combine the concepts to ensure the best sound reduction.

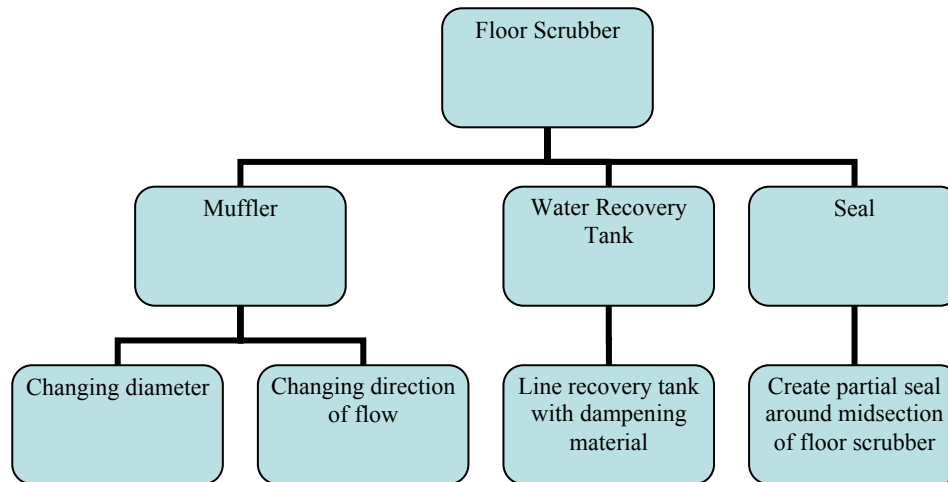

Figure 22 shows a flowchart which summarizes the sources of noise and concepts pursued.

7. CONCEPT SELECTION

After generating concept charts for the different components we would be addressing and choosing four concepts, we analyzed and compared all the concepts. We were only able to compare concepts for each component. We used a Pugh chart to compare the concepts for the muffler design but analyzed the water recovery tank and seal at the midsection systematically.

7.1 Muffler

We created a Pugh chart for the muffler design after designing the concept chart and finalizing four concepts. The Pugh chart served to compare our main concepts with respect to our design criteria. As shown in the chart below, the design criteria were ranked as 1 being the least important and 5 being the most important. We made our best design the datum to examine how the other designs rank compared.

As shown in the Pugh chart, two designs ranked the highest. Muffler with the varying diameter is one of our top designs because it is not going to need as much additional volume compared to other concepts but it might cost more to manufacture the actual product. We think it's worth pursuing this concept because it might produce very good results for reducing noise levels.

Muffler with the change in direction of flow was chosen as datum because it is our best concept. Making the noise travel longer distance and through curved channel would reduce the noise level significantly. One of the disadvantages of this concept is that it needs additional volume. Additional volume is one of our biggest constraints as we have very small space to redesign the muffler. We want to test the muffler with the varying diameter and also the muffler with the change in direction of flow using different testing methods for further quantitative analysis.

One of the main challenges of the muffler design is the quantification of its dimensions. Through some patent search we were able to obtain some empirical equations that help us in deciding the appropriate dimensions for our muffler but to apply those equations we are required to measure the speed, frequency and wavelength of sound through the muffler for which we do not have the equipment. To tackle this issue, we intend to adopt an iterative procedure of determining the optimal dimensions through lab testing.

Design Criteria	Weight	Design #1	Design #2	Design #3
		Varying diameter with lined closed cell foam	Changing the direction of flow in the muffler	Increasing length of the muffler
Lower noise level	5	0	-	-4
Cost	3	-2	D	2
Additional volume	3	2	A	2
Operating temperature	3	0	T	0
Long Life Span	3	0	U	0
Easily replaceable	1	0	M	2
Score		0	0	-6

Table 8 shows the Pugh Chart for the Muffler Design

7.2 Midsection of Floor Scrubber

The final concepts for the seal were to attach a partial seal to the midsection of the scrubber using rubber (butyl). We did not use a Pugh chart to select the final concept as our concepts have already been reduced to redesigning a specific component. Our concepts for this component are based only on material. The material selection is based on the effectiveness of the seal, thermal resistivity and thickness of the material. We chose rubber as our main material as we were able to find rubber that is thick enough to attach to the midsection and also because it is a good sealant. We will also consider other material once we are able to gather some quantitative data.

7.3 Water Recovery Tank

Concepts for the recovery tank also depended on material selection. Our material selection was limited because the usual dampening materials would not work for the tank. Since water and other dirt particles collect in the water tank, material such as foam cannot be used. To line the inside of the tank, we were able to choose materials such as the spray on foam and VBD-10 compound. The spray on foam is easy to use and would not conflict with the efficiency of the tank and the compound is proven to be an effective dampening material.

We want to use the spray on foam to test our tank because we are able to get the product immediately. If the spray proves to be ineffective in reducing the noise, we will consider using the VBD-10 compound. When we test, we plan to put a cardboard box inside the tank and use the foam on the box instead of applying directly to the tank. One of the precautions that we have to make is to ensure that while we test our spray foam, no water should be absorbed by the foam. Since this foam creates a permanent layer, presence of water inside the foam would deteriorate the walls of the recovery tank.

8. a DESIGN CONCEPT SELECTION

Although each design would produce a reduction in noise level, we feel that a combination of all three component design would reduce the noise level by 3 dBA. We would like to apply muffler with the change in direction of flow and varying diameter, the partial rubber seal as well as the lining in the tank.

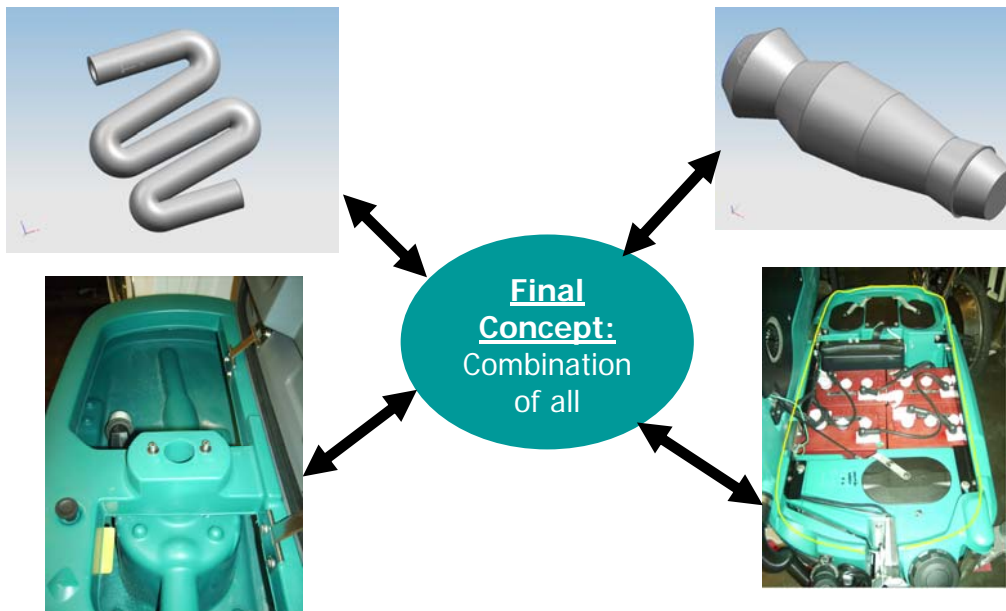

Figure 23 shows the final design concept: Combination of individual designs

As our project deals with independent components, we have to analyze each concept separately. Therefore, the combination of tackling all the sources of noise would be the best way to solve the problem. This may prove to be advantageous since addition of one design concept does not constrain other designs. Cost can be maintained to its minimum since foam tubing and rubber are the core materials used in our design, which happen to be fairly cheap to purchase. For an estimate, 12" x 12" pyramid foam would cost between \$3 and \$5. A 16 feet rubber seal can cost between \$10 and \$15. These are merely estimates and do not reflect the exact products that we intend to purchase. Further price search will be performed to reduce cost as much as possible.

Other customer requirements such as additional volume & weight, easily replaceable etc. are well within check. This concept maintains its compact size and the water tank. Neither the

muffler nor the rubber seal add a significant amount of weight or volume to the overall system. Comparing our final concept selection with the customer requirements, we feel that it is a good match. We cannot address any disadvantages since we have not yet tested our ideas. Based on our experimental results we will further progress on our project.

9. POST α -DESIGN ANALYSIS

After generating our α -design concepts, we decided to put it to test. Since our project relies on multiple tests through an iterative process it was important for us to perform lab testing to validate our ideas practically. Firstly with varying the diameter of the muffler we decided to take our current muffler and attach plastic fasteners along its length in order to create a ‘wavy’ contour. Upon testing it several times we observed no fluctuations in sound energy level. Since we could not back our idea mathematically nor come up with a moderation of this concept, we decided to eliminate this idea and decided to focus on updating our design concepts.

After our third sponsor meeting and proposing some of our ideas, we were specifically asked not to focus our design that would come in contact with water. The spray on foam were to be applied on the inside walls of the recovery tank that would be filled with dirty water. The risk here is that if the water happens to penetrate through the foam layer, it may cause bacteria and fungus within the recovery tank, thus producing bad odor and deteriorate the inner walls. Therefore this idea was dropped due to health and durability reasons. For the extended ‘S’ shaped muffler design, we wanted to further investigate the muffler design to see if we could produce a more efficient design. We decided to further research on exhaust muffler ideas. Lastly, we decided to pursue the rubber seal idea and performed some test around the mid-section of the machine. The results proved to be somewhat reasonable.

10. PARAMETER ANALYSIS

Through a series of discussion and lab testing we decided to expand our design possibilities into different directions. We did further patent/Journal study to determine means of noise reduction. This motivated us to do more sound testing and with the aid of software applications like ‘*audacity*’ and ‘*Sonic Visualizer*’ to study the sound waveforms in an effort to understand sound energy levels and frequencies generated. This aided us in developing both passive and active noise reduction ideas.

10.1 Muffler Design

Our concept selection showed two different designs for the muffler. We recommended a varying diameter as well as changing the direction of the flow. Changing the direction of the flow was an infeasible option because of space constraints. In our testing, we found that varying the diameter of the muffler did not produce sufficient results. Through research on various types of mufflers, we chose to design a reactive muffler with an expansion chamber to help us reduce the noise level of the floor scrubber.

When designing the reactive muffler with an expansion chamber, we made a few assumptions. We assumed that the sound wave pressure is much greater in the expansion chamber than in the inlet. Also, there are no reflected waves in the outlet and the expansion chamber walls do not conduct sound [20].

We calculated the diameter and the length of the expansion chamber keeping the inlet and outlet pipe the same diameter as the original muffler. We chose to keep the inlet and outlet diameter the same as the original because reducing it would cause back pressure to the motor resulting in failure of the motor. Increasing the diameter was not feasible due to space constraints.

From our frequency testing, we obtained a frequency of approximately 250 Hz as the peak frequency of the sound at the muffler using Audacity. We used 250 Hz as a range to accommodate both the dB and dBA scale. We assumed the temperature to be 60°C (140°F) as that's the maximum operating temperature in the floor scrubber. We used these values to find the speed and the wavelength of the sound wave. From the wavelength, we were able to calculate the optimal length of the expansion chamber, C to be 347.2 mm.

We assumed the transmission loss to be 10 dB to ensure that there would be significant amount of reduction in noise at the ear level. All equations used in the design process are outlined in Appendix 15.4. We then calculated the proportion, B/A , where B is the cross sectional area of the expansion chamber and A is the cross sectional area of the inlet/outlet pipe. Using the value of the original muffler diameter of 50.8 mm, we calculated the value of A to be 2026.83 mm², which we then used to calculate the value of B of 12490 mm². We were then able to deduce the diameter of the expansion chamber to be approximately 126 mm. Table 8 below summarizes some of the key values calculated during the design process.

Transmission Loss (dB)	10		B/A	6.162278
Frequency (Hz)	250		A-Cross sectional area of the inlet pipe (mm²)	2026.83
Temperature (°C)	60		B-Cross sectional area of the expansion chamber (mm²)	12489.89
Inlet/Outlet Diameter (mm)	50.8		d (mm)	126.1056
Speed of sound (m/s)	377.7686		Surface Area of expansion chamber (mm²)	137556.5
Wavelength (m)	1.388855		Surface Area of inlet/outlet pipe (mm²)	5053.7
C-Length of the expansion chamber (mm)	347.2138		Total Surface Area	142610.2

Total length of the inlet/outlet pipe (mm)	31.6662		Volume of expansion chamber (mm³)	4336662
			Volume of inlet/outlet pipe (mm³)	64182
			Total Volume (mm³)	4400844

Table 9 shows the quantitative results for the muffler design

To further help in sound attenuation, we wanted to insulate the surface of the entire muffler with fiberglass. We chose this material because it had a high noise reduction coefficient in comparison to other materials that we researched. The original length of the muffler is 378.88 mm and the expansion chamber length is 342.7 mm so we calculated the total surface area to be covered by fiberglass to be about 142610.2 mm².

Material	Max. Service Temperature (°C)	NRC	Cost (\$/kg)	Density (kg/m³)
Fiberglass	200	0.775	3.21	2600
Melamine foam	187	0.7	14.52	11.92
Polyether Vinyl foam	121.11	0.5	53.91	1537.77

Table 10 shows properties of different materials

10.2 Active Noise Cancellation

In order to further enhance our muffler concept, two design innovations may prove very useful in noise control which include active noise cancellation and resonator design. Over the years ‘active noise cancellation’ technology has been implemented in head phones to reduce background noise through electro-acoustical means where pulses of sound signals are released to negate the incoming noise with the same spatial geometry, amplitude and frequency but with an opposite polarity. This technology can also be implemented in a floor scrubber machine to reduce the noise produced from the machine. Before this concept is implemented it is important to understand the science behind noise cancellation.

It is a known fact that sound is a pressure wave which travels in a series of compressions and rarefactions. A noise cancellation device should produce a sound wave with the same amplitude but opposite polarity. Sound waves obey the principle of superposition. When the compression of a sound wave lines up with the rarefaction of another similar wave they cancel out each other causing a “destructive interference”. Using the same idea noise cancellation headphones is designed.

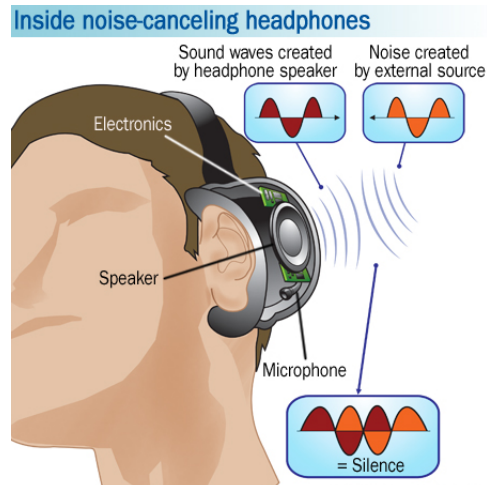

Figure 24 illustrates the simple function of a noise cancellation headphone

This concept can be implemented in the floor scrubber by placing a small speaker and microphone under the hood of the recovery tank.

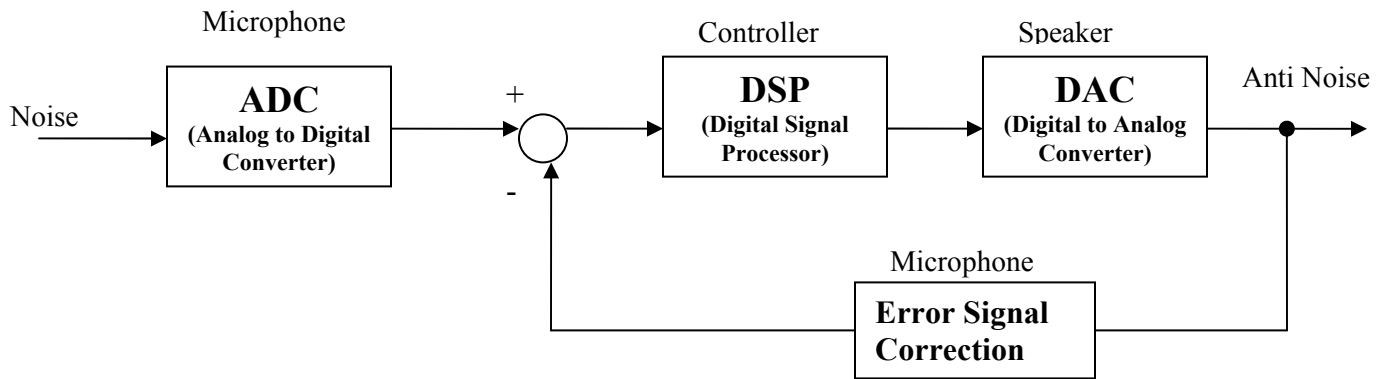

Figure 25 illustrates a block diagram for a feedback system for Active noise cancellation technology

The block diagram above shows the operation behind active noise cancellation. The incoming noise is first converted to digital signals using an ‘Analog to Digital converter’. These electrical pulses are then passed on to a ‘Digital Signal Processor’ which converts signals to opposite polarity. If there is still some discrepancy between the incoming noise and the output, it is fed back into the system to reduce system error to zero. These electrical signals are then converted back in to sound using a ‘Digital to Analog converter’ and thus canceling unwanted noise.

The two main areas of interest where such a technology can be implemented are next to motor fan and in the recovery tank of the floor scrubber. Since sound is a form of energy it is measured both in decibels and Watts. The relation of decibel and Watt is given by Equation 1:

$$W(\text{decibels}) = 10 \log W(\text{watts}) + 120\text{dB} \quad (\text{Eq 1})$$

W is the acoustic power. We generated the frequency spectrum around different positions of the recovery tank and motor fan to determine which sound frequencies contribute most to overall noise. From the spectrum plot we obtained the following data:

Position	Dominant Frequency (Hz)	dB
Back	249	7
Fan Face	203	6
Front	272	6

Table 11 lists the frequency and sound level close to the motor fan

Position	Dominant Frequency (Hz)	dB
Center	363	0
	2102	-2
Front	89	-2
Left side	180	7
	1965	6
Rear	157	12
Right side	180	9

Table 12 lists the frequency and sound level in the recovery tank

The exact locations of the measurement points can be seen in the figure 2 in Appendix 2.

Active noise cancellation (ANC) works best for low sound frequencies and for simple spatial fields. Active noise control work best when the wavelength is long compared to the surrounding dimensions [9]. However the dimensions should not be exceed more than $0.8 \times \text{wavelength}$ to prevent back pressure. Such a technology is more effective for low frequencies because as the frequencies increase, sound fields tend to become more complex that it may be difficult for a single controller to handle multiple noise frequencies. The ANC should be placed very close to the noise source and oriented in a way that would cause maximum destructive interference [10].

Low frequencies in terms of ANC depend a lot on the controller implemented into the system. One specific controller (Digital Signal Processor) by Texas instrument ‘TMS 320’ is capable of controlling high energy sound in the bandwidth of 100-500 Hz. A typical ANC device consists of speaker/s, microphone/s (for multiple detection), the only expensive item is the DSP, an electronic circuit board that performs all the calculations to produce an anti-noise. There may be other ANC devices that are capable of reducing noise across a larger frequency.

The equation below is a simple relation between frequency and wavelength of sound wave.

$$f = \frac{c}{\lambda} \quad (\text{Eq 3})$$

Where f is the sound frequency, c is the speed of sound and the λ is the wavelength. Since frequency and wavelength are inversely proportional, lower frequencies imply longer wavelength. To calculate the wavelength we had to first determine the speed of sound using an empirical equation given by the expression:

$$c = 49\sqrt{459.7 + 1.8^\circ C + 32} \quad (\text{Eq 4})$$

Where °C is the temperature in Celsius. Based on Temp 22°C the speed was found to be 344.632m/s.

10.2.1 Lab Testing For Active Noise Cancellation

When noise travels from the reference microphone to the speaker there is some time delay associated with all the electronics in processing the information. The DSP needs to process all the information before the noise reaches the speaker. The digital processing requires processing time 't' to be less than the sampling time f_s . The expression is given by [13]

To test the feasibility of the ANC technology, we performed sound tests at different locations around the floor scrubber using a pair of JVC Noise Canceling Headphones with model # HA-NC 100. A microphone was attached between the headphones and placed at various noise sources. The scrubber was operated and using software called '*Sonic Visualiser*' to study the waveforms of noise and to determine if the presence of ANC affects the noise level.



Figure 26 illustrates the active noise canceling headphones with a microphone embedded between the ear muffs

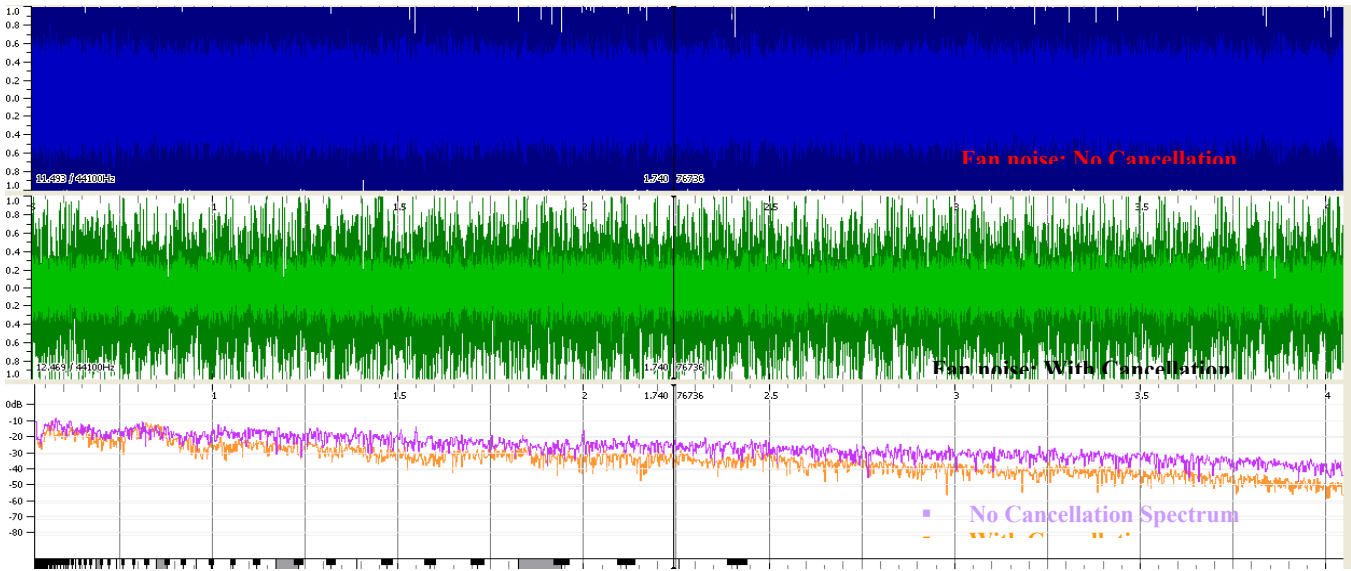

Figure 27 waveform & spectrum of noise from fan with and without active noise control

The above plot shows results for sound test performed around the face of the motor fan. From the waveforms and the spectrum plots we see a reasonable amount of noise reduction. There is noise reduction observed at various locations in the range of 1.5-2 dB. There is reduction evident in the lower frequency range of 100-700 Hz. dBA scale is an average measure over a range of frequencies, therefore both the low and the high frequencies are important for to determine sound reduction. From the above plot we observe that a lot of energy reduces at high frequencies.

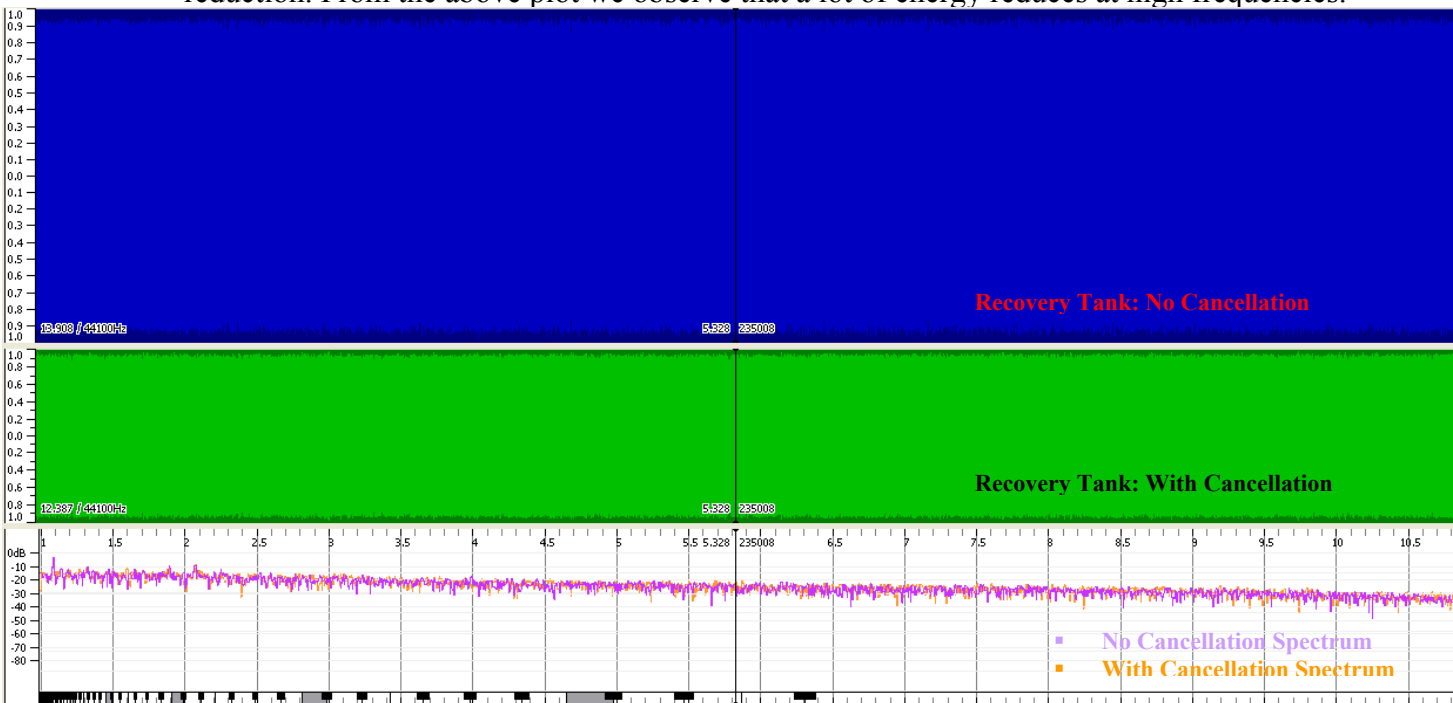

Figure 28 illustrates the waveform & spectrum of noise inside the recovery tank with and without active noise control

The results from inside the recovery tank show enormous amount of sound energy levels present. Although the frequency spectrums may appear to overlap each other, however at lower frequencies noise cancellation does attenuate some amount of noise. The reason for spectrum overlap is because in an enclosed space noise random travels in all directions. Unlike a fan or a pipe is difficult to restrict to motion of the sound in a specific direction. However a combination of ANC devices may significantly contribute to the overall noise reduction of the machine. Since most of the noise in the recovery tank is due emitted from the motor (closely attached) and get accumulated with in the tank space. One means to tackle this would be to place the noise control device close to the motor. Further details of design and installation are discussed in the next section of Fabrication.....

10.2.2 A.N.C Approaches and Sampling Rate

Along with reducing noise at lower frequencies another important thing for optimal use of ANC is to confine the flow of sound in one direction. The figure below illustrates this point using a *feedforward* system. When noise travels from the reference microphone to the speaker there is some time delay associated with all the electronics in processing the information. The DSP needs to process all the information before the noise reaches the speaker. The digital processing requires processing time 't' to be less than the sampling rate f_s .

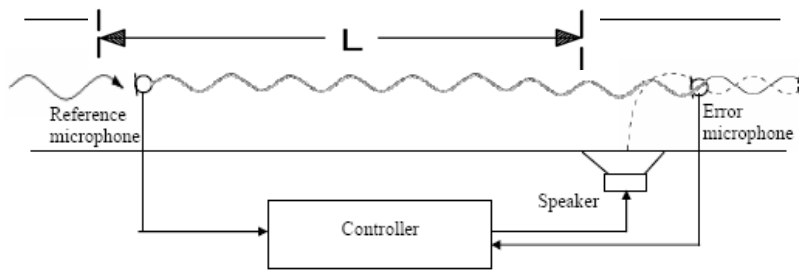

Figure 29 Feedforward active noise control system for attenuating sound propagation in a duct/tunnel[10].

The digital signal processor requires that the processing time 't' be less than sampling Time period 'T':

$$t < T = \frac{1}{f_s} \quad (\text{Eq 5})$$

Another important constant called the frequency of interest f_m is a reference frequency used to determine the sampling rate. Generally f_m is rated at about 500 Hz for most systems [13]. Many scientific journals approximate the sampling rate based on the following inequality:

$$f_s \geq 2f_m \quad (\text{Eq 6})$$

$$\rightarrow f_s \geq 2(500)$$

$$\rightarrow t < \frac{1}{1000} = 1ms$$

To determine the location of the reference microphone and the speaker based on the expression:

$$L = \delta_A * c \quad (\text{Eq 7})$$

For most common applications the rating for Acoustic delay is 0.2msec [14]. Based on the above equation, the suitable distance would be 68.9 mm

10.3 Rubber Seal

For testing purposes we decided to apply a layer of ‘EPDM’ rubber seal around the mid-section of the machine, we re-measured the sound levels at different locations and created a sound map. We observed that the sound at Ear level did not change, however the sound around the mid-section did happen to reduce by some amount.



Figure 30 & 31 Sound maps for the left and right side of the floor scrubber with attached rubber seal (measured in dBA)



Figure 32 Sound map for the front and top of the floor scrubber with attached rubber seal (measured in dBA)

From the above sound maps, we observe some amount of sound reduction, especially through the midsection. Since the Ear-level noise being consistent proves that the noise that escapes through

from the mid-section does not contribute to the overall noise level at the Ear. Instead this sound flows in other possible directions. It is worth considering this idea, since is being reduced along other directions.

10.4 Elbow Design

Our experimental testing was further advanced into as far as measuring noise around the elbow pipe. A lot of the noise travels through the stand pipe connecting the vacuum motor and the elbow pipe. Sound measurements were performed with and without the elbow pipe shown below



Figure 33 close up picture of the original elbow pipe design

From the first set of tests we found the following results:

Test Setup	Position of measurement	
	In front of hole pipe (dBA)	On top of hole pipe (dBA)
with elbow pipe	97	95
without elbow pipe	90	99

Table 13 Test results for the existing elbow design.

By observing the above results we see that in the presence of the original elbow pipe, the more noise is generated. When sound is measured over the top of the outlet hole, some sound is still attenuated through the elbow pipe as compared to an open hole. Based on the collected data, the following frequency spectrum shows lower energy levels without the elbow through the entire spectrum.

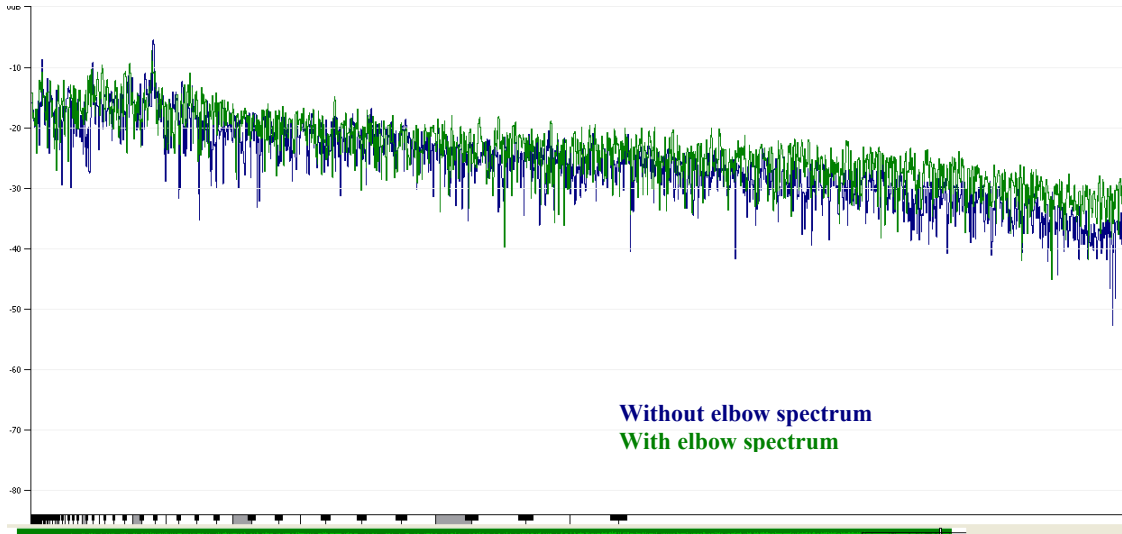

Figure 34 illustrates the spectrum of noise with and without elbow

From the above tabulated results and graph, some very important conclusions can be drawn:

- The current elbow design produces higher energies
- A lot of noise escapes through the stand pipe
- Some attenuation is observed when the elbow is placed over the hole and sound is measured at that position.

From this we concluded that the current elbow pipe is a bad design and requires some attention in redesigning. In acoustics one of the famous beliefs is that sound attenuates with distance. Mathematically given by the expression:

$$I_s \propto \frac{1}{r^2} \quad (\text{Eq##})$$

This simply states that sound intensity is inversely proportional to the square of the distance. The longer the sound travels through a specific medium the more energy it loses. To validate this idea, we decided to perform a rough test using a long foam pipe as seen below.

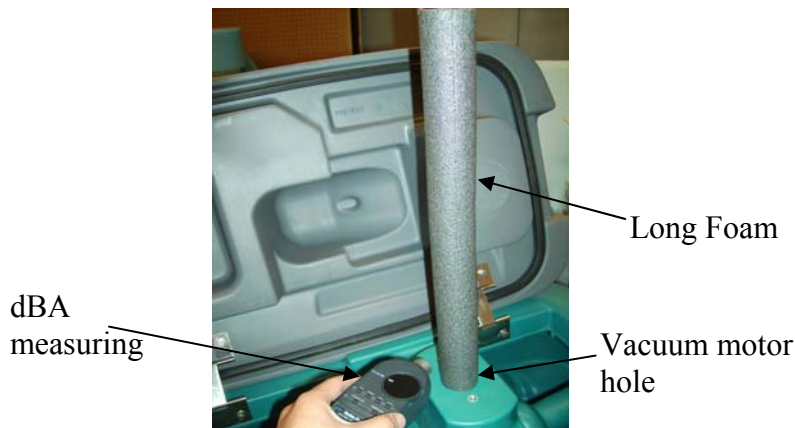

Figure 35 illustrates the long foam pipe used to test sound attenuation along its length

The dBA meter measured the sound level at different locations along the foam pipe. The measured value from the device is the Sound Power Level (SPL) dBA. To convert to Sound intensity the following relationship had to be used:

$$SPL = 10 \log \frac{I_s}{1 \times 10^{-12}} \quad (\text{Eq##})$$

The following results were obtained :

Distance away from hole (mm)	dBA	I _s (Watts)
20	88	6.31*10 ⁻⁴
230	87	5.01*10 ⁻⁴
320	84	2.51*10 ⁻⁴
480	82	1.58*10 ⁻⁴

Table 14 lists the experimental values and its corresponding intensities

Using to any two intensities and its corresponding distances the inverse square law can be validated. For instance,

$$\rightarrow 5.01 \times 10^{-4} * (230)^2 = I_2 * (320)^2$$

$$\rightarrow I_2 = 2.58 \times 10^{-4} \approx 2.51 \times 10^{-4}$$

Thus the law is valid in our case. Therefore length elongation of the elbow pipe can prove to be a feasible option.

One assumption made during this test was that, all results were attributed to the change in length (450mm) and not the material of the pipe. Form the sound test we found that the noise level fell to 88dBA. A frequency spectrum below shows the results that were obtained

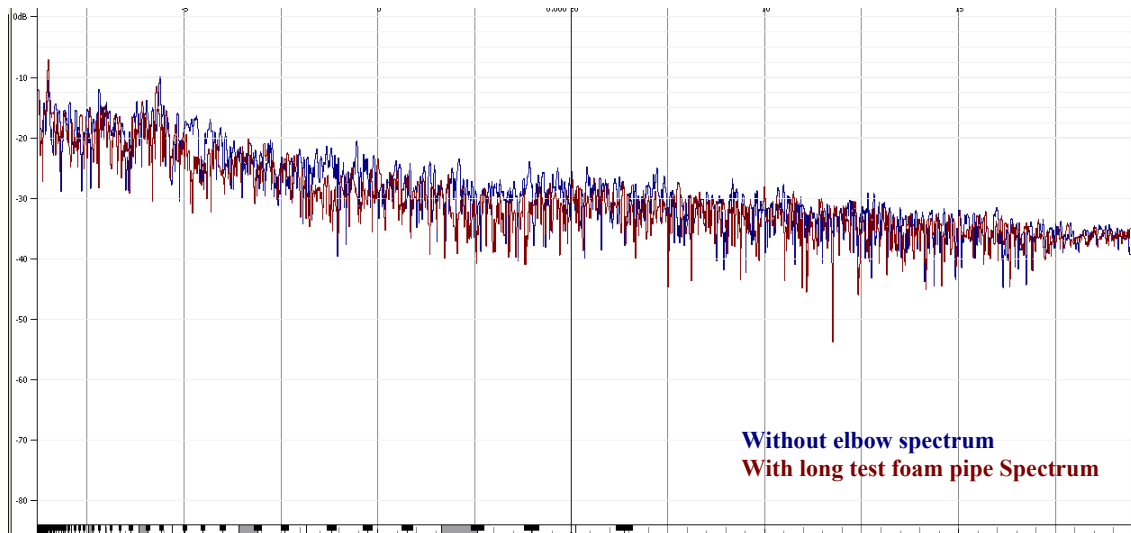

Figure 36 illustrates the spectrum of noise with a long test foam pipe and without elbow

The spectrum shows that along the entire spectrum long pipe has lower energy states although it does overlap with its competing spectrum but it is evident that the red spectrum does not have

higher peaks than the blue spectrum. Therefore redesigning the elbow is a feasible option that we considered. All dBA spectrums are given in Appendix ##.

10.5 Design Analysis Assignment

In addition to the parameter analysis, we performed a Design Analysis for our Final Design. Design Analysis helped us in understanding our design from a broader sense. With the aid of computer software we were able to make judgments about material selection, assembly, environmental, safety and manufacturing issues relating to our design. The Cambridge Engineering Selector helped us to identify various materials that would be applicable to our design.

Since a wide manufacturing work involves assembly of parts, Design for Assembly (DFA) was a very useful tool that helped us in improving our assembly process. The main objectives of DFA are to reduce number of parts and simplify the assembly process (*Lecture: Kota*) as a result increasing manufacturing efficiency and reducing cost. More details about DFA for our design are given in Appendix C. everybody wants to safe from dangers and safety is the key to survival. From Design for Safety we learned two important things: hazards associated with our design and different failures associated with our equipment. By determining the different hazards associated with our design we are able to recommend safety measures that can taken to eliminate risks as much as possible. Failure Modes and Effects Analysis (FMEA) is another method of optimizing our design by helping us determine the potential failures associated with our design. Frequent system failure is very costly. By detecting the failure modes at an early stage and eliminating the chances of occurrence we can reduce these costs. More details about risk assessment and FMEA are discussed in Appendix C. Lastly Manufacturing Process Selection is all about selecting the most optimal manufacturing process for our design based on the feature size, material, costs and economic batch size. By selecting the appropriate manufacturing process we are able to minimize cost and labor time thus improving overall manufacturing efficiency.

10.5.1 Material Selection Assignment

Using Cambridge Engineering Selector, we entered our engineering specifications to condense our choice of materials. We entered the temperature and cost specifications to identify materials that qualified these specifications. We also used the selector to determine the common uses of these materials. After further analysis, we narrowed down our choices to polyurethane foam for the insulation material and polyethylene for the casing. Further details of the analysis are listed in Appendix C.

10.5.2 Design for Assembly

We applied the DFA concept for the elbow pipe design. Initially designed as a 5 separate parts, the elbow pipe had an assembly cost of 58.4 seconds with an assembly time of 23.36 cents. The overall assembly efficiency the original design was 15.41 %. After applying the DFA charts/concepts we reduced our design to a 3 component system lowering the assembly time and cost by 36.8 seconds and 14.72 cents respectively, increasing the assembly efficiency to 24.45%. We recommend the combination of elbow pipe, the mounts and the clamps. The clamps to be replaced to screw bolts to snap on bolts that do not require any turning and simply attach to the hole when pushed on it. For more details refer to Appendix C

10.5.3 Design for Environmental Sustainability

Using SimaPro, we were able to further analyze the environmental impact of the materials chose from CES. For the elbow casing, we found that high density polyethylene had a better impact on environment over propylene. For the insulation, we found that melamine foam was better for the environment than polyurethane foam. However, we recommend polyurethane foam because it would be more applicable to our design.

10.5.4 Design for Safety

For risk assessment we listed some of the hazards/risks associated with the operator are high noise level which could cause hearing problems and high vacuum pressure which may cause injuries especially if someone were to place their hand close to it. To tackle this issue we recommended the use of hearing protection and Electronic stop valve that would shut off the motor if something gets stuck in the vacuum pipe and interrupts the air flow. There are numerous failures associated with the machine. Some of the failures associated with the scrubber are increased vibrations and sound resonance mainly due to assembly errors and component fatigue. To tackle this issue we recommend that the components be fitted tightly to the main scrubber body to minimize vibrations and perform multiple test run to determine the fatigue life of the components.

10.5.5 Manufacturing Process Selection

From our discussion with our Sponsor Mr. Fred Hekman from Tennant Company, we found out that Tennant company produces their floor scrubber every day at an average of about 40-50 machines per day. To make their process as efficient as possible we recommend the use of injection molding for the exterior of the elbow pipe and polymer extrusion for the inner insulation. The two materials can be attached using neoprene adhesives. More details are listed in Appendix C.

11. FINAL DESIGN DESCRIPTION

For our final design we have listed the individual components, the CAD models with appropriate dimensions.

11.1 Elbow Pipe Redesign

The final design for the elbow pipe is shown in the figures below with appropriate dimensions.

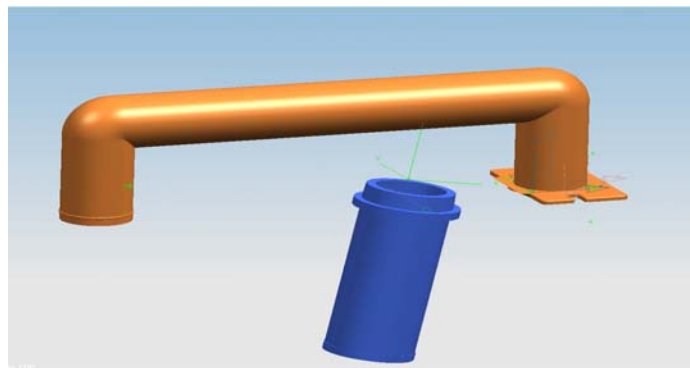
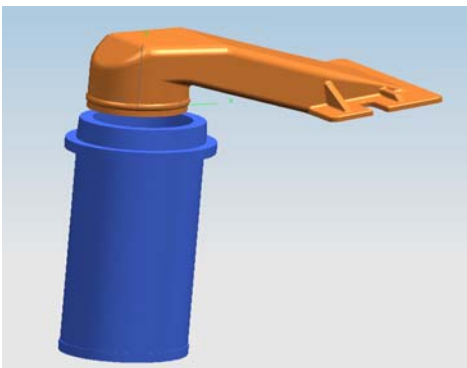

Figure 37 & 38 illustrates the original and the new elbow pipe design respectively.

By comparing the original and with new elbow pipe design, some of the main differences include the length and the pipe orientation. The length helps is attenuating sound better. From our lab experiments (As mentioned above) we were able to validate the relationship between length and noise level. The length of the elbow has been increase from 135.1mm to 270.8 mm, increasing the volume by about $6.5 \cdot 10^5 \text{mm}^3$. An inner wall insulation of 2mm thickness should be placed for further noise reduction. The recommended material for the exterior wall should be made from High Density Polyethylene (HDPE) due to its high durability: tensile strength(58.6 MPa), Max. service temperature (150°C). The interior insulation should be made from Polyurethane foam which has a Noise reduction coefficient of 0.20. NRC value is the average of four sound absorption coefficients of the particular surface at frequencies of 250 Hz, 500 Hz, 1000 Hz, and 2000 Hz. These frequencies encompass the fundamental frequencies and first few overtones of typical human speech, and, therefore, the NRC provides a decent and simple quantification of how well the particular surface will absorb the human voice. A more broad frequency range should be considered for applications such as music or controlling mechanical noise.

$$NRC = \frac{\alpha_{250} + \alpha_{500} + \alpha_{1000} + \alpha_{2000}}{4} \quad (\text{Eq##})$$

Therefore an NRC value of 0.2 implies that of all the sound that penetrates through this material 20% gets absorbed.

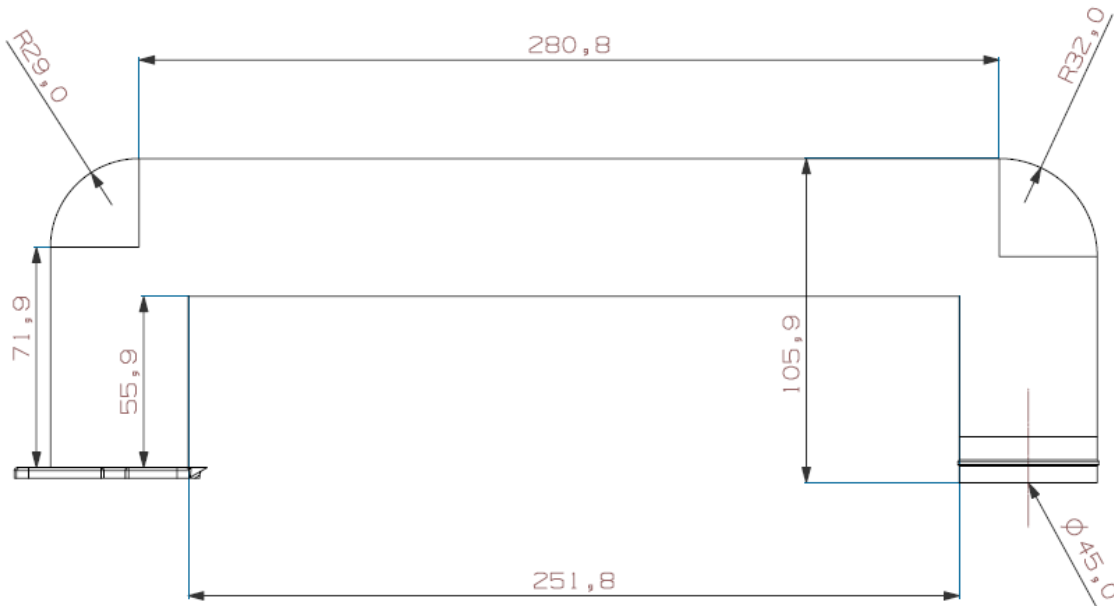

Figure 39 illustrates the side view of the elbow pipe with dimensions (mm)

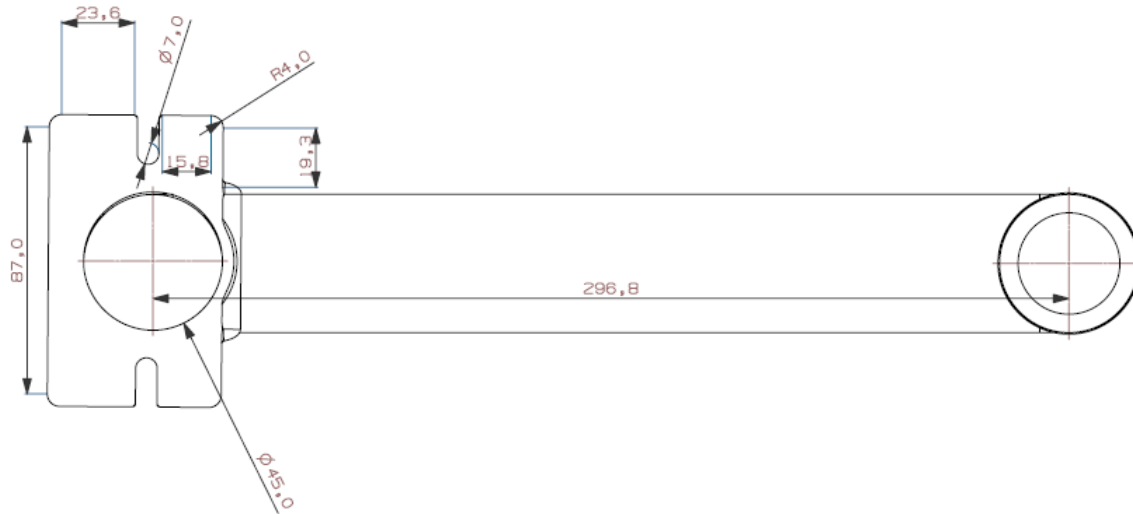

Figure 40 illustrates the bottom view of the elbow pipe with dimensions (mm)

11.2 Muffler Redesign

The existing muffler has a wire mesh that holds the shape of the muffler with foam wrapped around it. Black tape is used to hold the foam in place. We recommend that the wire mesh be used for the new muffler design as well. Generally, metals such as aluminum and steel are used for a muffler but in this case, we are trying to insulate the muffler so we can attenuate sound. We feel that insulating the metal on the outside would not produce reduction in noise. We cannot insulate the inside of the muffler because reducing the diameter with the foam thickness would cause back pressure. Keeping the dimensions as calculated and following customer requirements, we feel that it is best to insulate the outside of the muffler. Therefore we feel that using a wire mesh with foam around it would make sound absorption more efficient as the foam comes in direct contact with the sound.

We chose fiberglass to be the best material as the noise reduction coefficient was the greatest. Since the fiberglass is covering a surface area of 142610.2 mm^2 , the total cost to do this would be \$14.35.

Based on the dimensions, we created a CAD model representing the reactive muffler. The model specifies the dimensions of the inlet/outlet pipe as well as the expansion chamber. The dimensions of the expansion chamber will affect the contour of the existing polyethylene mold but they will not significantly increase the overall volume of the scrubber.

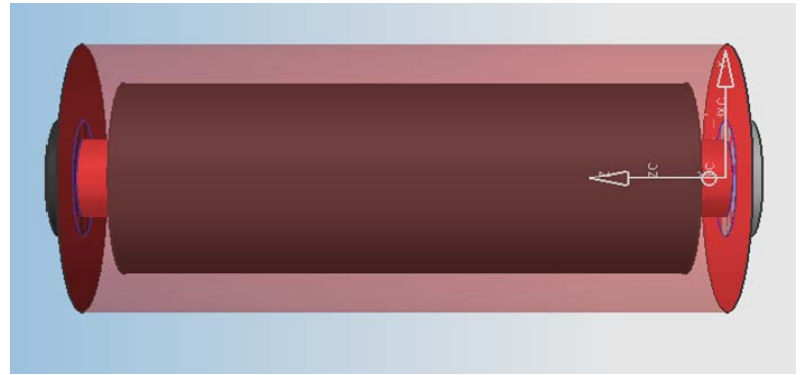
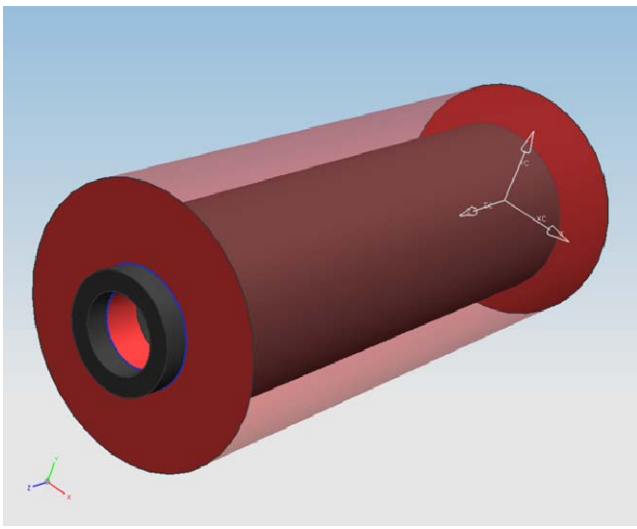

Figures 41 & 42 orthographic and side view of the muffler redesign

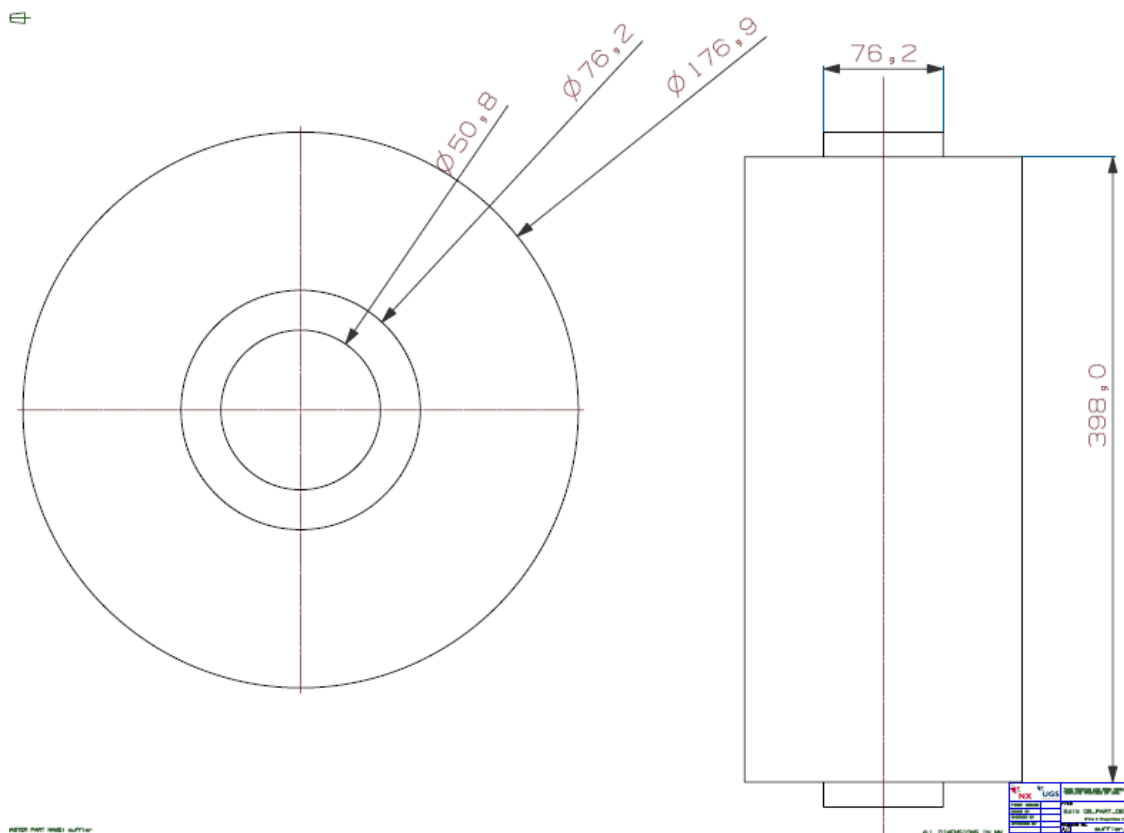

Figures 43 & 44 dimensioned drawings of the muffler front and top view (mm)

11.3 Isolator Gaskets

Another point of high interest for sound attenuation is the addition of isolator mounts also known as isolator gaskets. Currently, when the motor is mounted, a gasket fills the space between the top of the motor and polyethylene body. The gasket is 12.7 mm thick with an outer diameter of 146 mm and inner diameter of 66.6 mm. The material is ethylene propylene diene monomer rubber, EPDM SC42, and attached to the motor with a Pressure-Sensitive Adhesive (PSA). It is assumed that Tennant has rigorously tested this vacuum motor gasket and designed it very well.

Naturally, metal to metal contact allows sound to resonate. The current vacuum motor mounting system uses three steel bolts with steel spacers and a steel mounting bracket to hold the motor in place. The steel bolts are 140.0mm in length; the steel spacers are 106.82mm in length, 7.0mm inner diameter and 11.0mm outer diameter. Ideally, we desire to add a gasket in every part of the mounting system where metal to metal or metal to polyethylene contact exists. At this time we will focus our attention to the top of the motor.

Presently, the metal spacers wrap around the mounting bolts and are in direct contact with the polyethylene body on top and steel mounting bracket on the bottom. Three gaskets of the same dimensions and material will be added to fill the space between the top of the steel spacers and polyethylene body. The spacers will be cut to accommodate the 12.7mm thickness of the gaskets. The gaskets will be made of the same EPDM SC42 material which Tennant has very carefully chosen for its sound attenuation ability. Each gasket will be 12.7mm thick with 12.0mm outer diameter and 7.0mm inner diameter. This same method may also prove promising for the opposite end of the spacer which connects directly to mounting bracket.

11.4 Seal

Based on our experimental results above we see that a Seal around the mid-section of the floor scrubber proved to be a useful concept to be implemented in our final design. here is photograph of the mid-section with seal attached. We recommend the use of EPDM foam due to reasonably good NRC rating and high service temperature. The length required for the EPDM strip is ≈ 2133.56 mm.

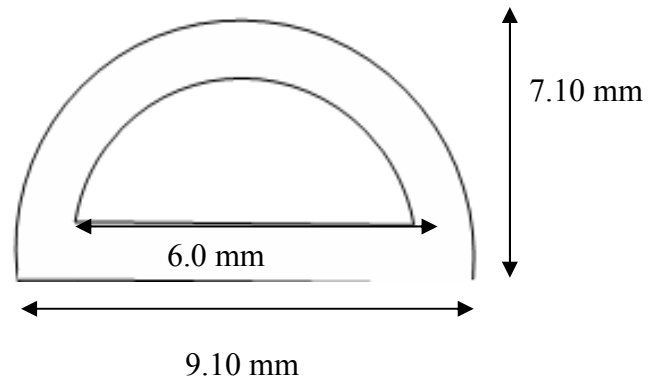

Figures 45 & 46 shows the aerial view and the cross-sectional view of the rubber seal with dimensions.

11.5 Motor Insulation

Based on our previous calculations around the elbow design and determining that the motor being the main source of noise, we decided to insulate the surrounding walls of the motor to suppress the sound being produced from it. The vacant space between the motor and the scrubber body can be insulated with some sound insulation material.

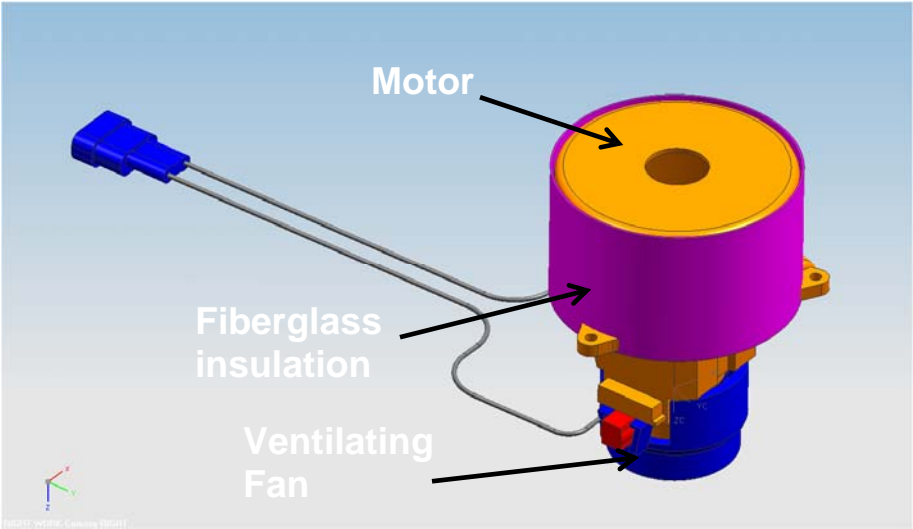

Figure 47 orthographic motor with insulation

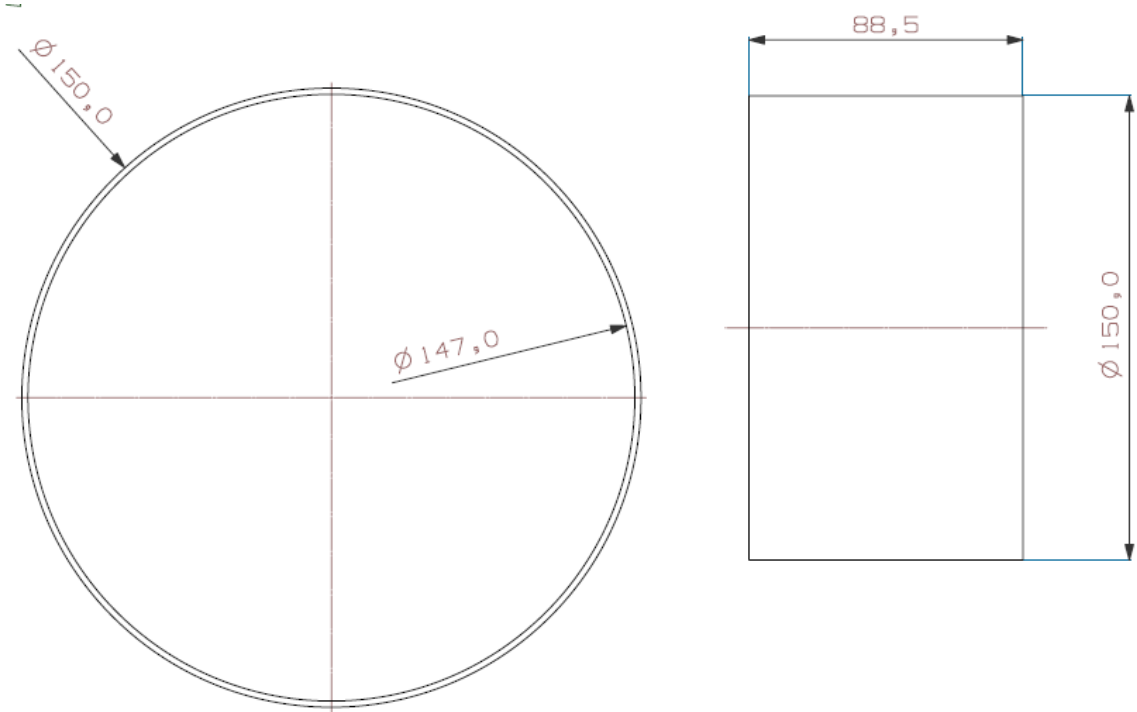

Figure 48 & 49 front and side view of the insulation with dimensions

The material that we recommend is R-13 Fiberglass insulation with a high NRC value of 0.775 providing a good amount of acoustical insulation [18]. Although we had more room for insulation we chose to keep it at this thickness so that we don't over heat the motor by blocking its natural heat convection. It is still safe to insulate the motor simply because there is air circulating internally due the vacuum and the ventilation fan.

11.6 Active Noise Control

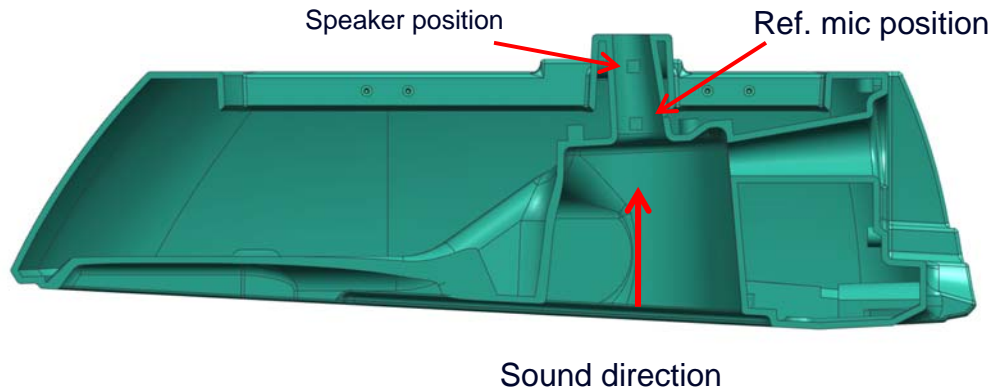

Figure 50 illustrates the enclosure where the ANC devices are to be placed and sound direction.

11.6.1 Component Selection and Analysis

Many different components have to be selected for the redesign and additions to the floor scrubber machine. It was important for us to maintain cost, reliability and manufacturability of our products.

Since most of design revolves around material selection and purchasing manufactured products from the market, some of the components that have to be designed include:

11.6.2 Design of Active Noise Controller

A regular Active Noise Cancellation (ANC) kit comprises of:

- Input Microphone: for detecting surrounding noise
- Error Microphone: senses the noise at which noise reduction is required and monitors how well the ANC system performs.
- Speaker: for producing sound waves for sound negation.
- Controller: for measuring reference signals and calculating what is required to cancel noise.

The most sophisticated device of them all is the Controller which comprises of many subparts which are responsible for producing the best results. To better understand the component selection and the process, a detailed breakdown of an ANC system is shown below.

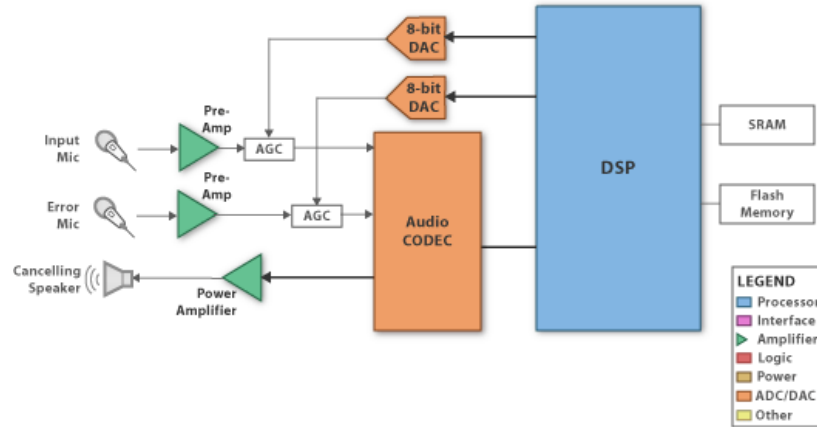

Figure 51 shows logic circuit design for ANC

Some of the components may seem to be familiar from before. Some of the new subcomponents include:

- Operational Amplifiers: Implemented with microphones and speakers to produce/detect superior sound quality with exceptionally high speed.
- Audio Codec: The residual noise signals are converted to digital form by the ADC. The DAC generates the output anti-noise signals.

11.6.3 Microphones

Any microphone can be used for this system. There is no size constraint on the microphone as long as packing within the small space is possible, there should not be any problem with operating this setup provided the distance constraint is met.

11.6.4 Operational Amplifiers (Pre-Amplification)

Operational Amplifiers are connected to the microphones for signal amplification purposes. Any kind of microphone can be used, what determines the performance of ANC technology is the Op Amp. The most suitable device we found was produced by Texas Instruments (TI) with model # OPA 2134 [13].



Figure 52 shows an actual OP Amp chip for ANC system

This device is able to process superior quality sound with a very low distortion of about 0.00008%. Total Harmonic Distortion (THD) is a measure of difference between the actual signal and the detected signal. The lower the distortions better the signal detection capabilities. It has a high processing bandwidth of 8 MHz with a high operating temperature up to 125°C. The retail cost price is only \$1.10.

11.6.5 Power Amplifiers

This device is connected to the canceling speaker. It is capable of producing crisp quality sound by amplifying the electrical signals it receives from the DSP. The model number for the part is TPA 6203A1 [13]. It operates with a very low THD value of 1%. It is a low power consuming device with a rating of 1.25W. Compact in size and can with stand temperatures up to 85°C. The retail unit price is only \$0.45.

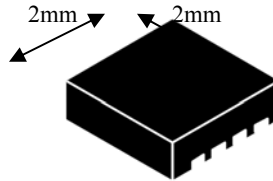

Figure 53 shows a power Amplifier chip with dimensions

11.6.6 Audio Codec

The Audio Codec selected for this application is TLV320AIC23B [13]. The Audio Codec is a periphery between the microphones, speakers and the DSP. The setup apparatus is shown in Appendix ##. This device has a high sampling rate of $256 f_s$ and $384 f_s$ which means more information can be processed in a small amount time. The Signal to Noise ratio (SNR) is 90 dBA. The higher the SNR the less obtrusive the background noise is. The power consumption is only 23mW. The operating temperature range is -40°C to 85°C with a total board area of 25mm^2 . The retail price of a unit is \$3.75.

11.6.7 Digital to Analog Converter (DAC)

This device is used to convert electrical signals from the DSP into Analog signals which are sent to microphones. The model number for the product is DAC5571 [13]. It requires a small amount of power, operating at 3V and $125\mu\text{A}$. The operating temperature range is -40°C to 105°C . The unit price for the item is \$1.15



Figure 54 shows a Digital to Analog converter chip.

11.6.8 Digital Signal Processor (Controller)

This controller device detects incoming noise from the microphone, processes the data and produces electrical signals which are passed on to a speaker for noise cancellation. The recommended device is TMS320VC5502 [13]. It has a sampling rate of 200MHz. it operates optimally in the temperature range of -40°C to 85°C . The retail cost of the product is \$7.5.

A lot of the details about ANC technology has been discussed earlier. The above illustration shows the placement of the ANC devices within the stand pipe. The idea is that if sound is captured in a confined volume a lot of sound can be negated before it diffuses into other spaces. The stand pipe being a close space with a hole on the top leading into the recovery tank. Since the recovery tank is a hollow volume, it is susceptible to noise reverberation. If sound can be cancelled before entering the recovery tank, no reverberation will occur. We plan on

demonstrating this concept with the help of an Active Noise Canceling headset (JVC HA-NC 100). More details are discussed under Fabrication Plan.

11.7 Final Design Summary

The picture below shows the final design for the Tennant T5 floor scrubber.

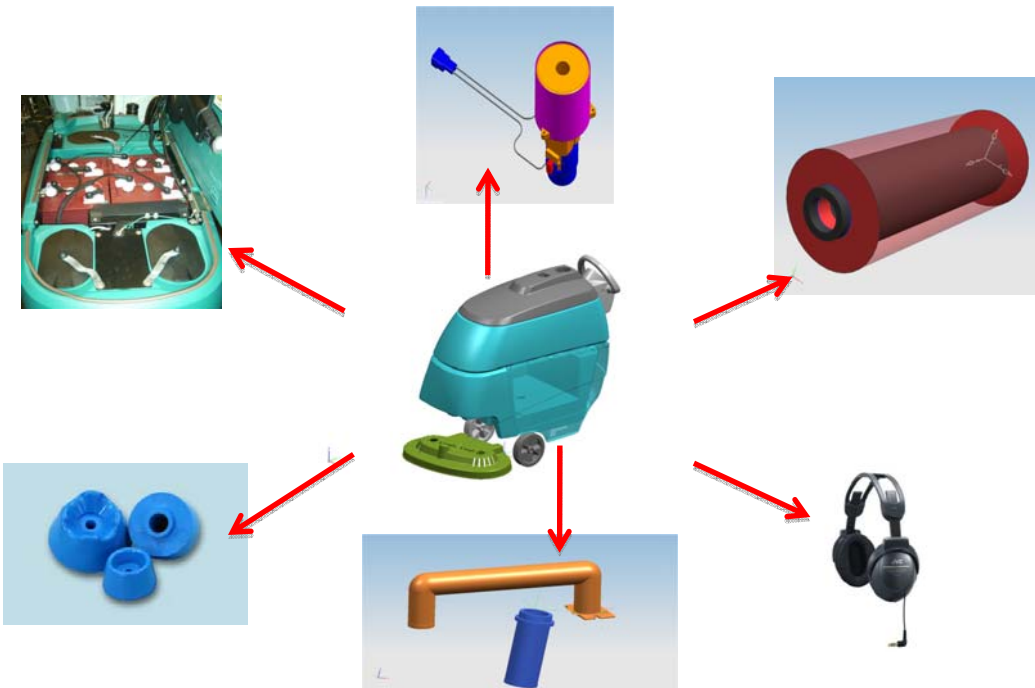

Figure 55 illustrates all 6 design concepts that need to be implemented into the floor scrubber

12. PROTOTYPE AND FABRICATION DESCRIPTION

The final design components were prototyped to be exhibited at the Design Expo. Due to the constraint on time, materials and manufacturing equipment we produced a prototype of our original model. Since our final design is a combination of multiple concepts put together, each of the different design concepts were dealt with separately.

12.1 Elbow Pipe Design

We produced a prototype using PVC pipe. The prototype was not built to scale because PVC pipes are mass produced in standard sizes which were not a match to the dimensions of our final design. The emphasis is on the length of the re-designed Elbow which is believed to be the main contributor to the sound reduction in the Elbow. Although the inside pipe contains an acoustic insulation lining and the exterior is recommended to be made from High Density Polyethylene

(HDPE) for its high durability, due to the manufacturing limitations these are not evident in the model. Once the prototype was manufactured, we performed mock test by replacing the current elbow pipe with the prototype to ensure that the prototype can withstand high air pressure. We had to make sure that the prototype blended to match the actual design as much as possible. The main purpose of having a bend is mainly because sharp corners tend to have higher stress and thus leader shorter operating cycles. These stresses may develop due to high air pressure blowing through the elbow pipe. More details about fabrication can be found in Appendix A under Process Plan Sheets. Information about the parts that were purchased can be found in the Appendix A under Bill of Materials. An elbow pipe mount was also manufactured to balance to the elbow pipe when installing it into the recovery tank. More details on that are discussed under ‘Engineering Design Changes’ in Appendix B.



Figure 56 illustrates the elbow pipe prototype.

Since floor scrubbers are mass manufactured every day, the actual components cannot be manufactured in the same manner as explained in the process plan sheet. To produce actual components we recommend industrial manufacturing processes especially rotomolding. Rotomolding is a very useful process for plastic parts and very cost effective. In this process powdered form plastic is inserted into a mold and heated to high temperatures in an oven while rotating causing the melted plastic to stick to mold wall and taking up its shape. Since Tennant has been manufacturing many of its parts using this process, it would be the most cost effective approach for them to adopt. A block diagram for the assembly of the Elbow pipe is shown below:

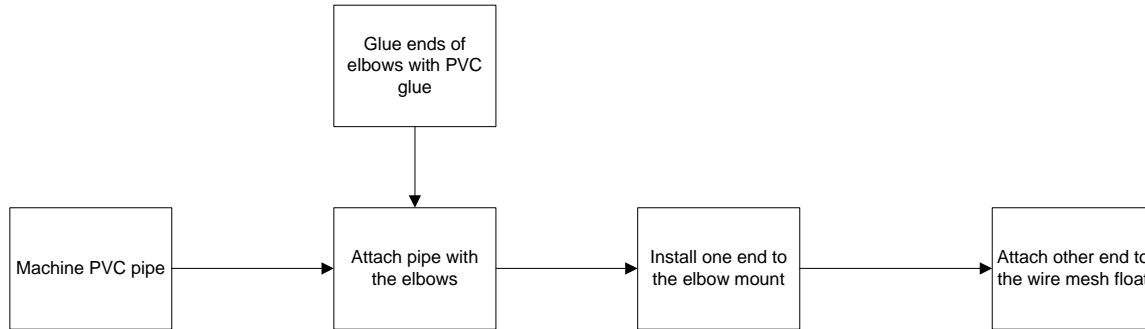

Figure 57 illustrates the assembly plan of the elbow pipe to the mount and the float (assuming the mount is already attached to the recovery tank)

12.2 Muffler Design

Since the muffler is one of the most important components of our design, it was essential for us to manufacture a prototype for it. Since our design concept is an expansion chamber muffler with insulation, we constructed it using cylinder pipes made of PVC. The acoustical insulation was modeled using EPDM lining sheets. A lot of the manufacturing involved band sawing. A more descriptive detail for manufacturing the muffler is given in the Appendix A under 'Process Plan Sheets'. Information about the parts that were purchased can be found in the Appendix A under Bill of Materials.



Figure 58 illustrates the expansion muffler prototype

When making our final prototype, we kept our size constraints as close to the final design as possible. We made the muffler out of PVC since the material we needed was difficult to obtain at the time. Because of this, it was impossible to test the sound reduction qualities of our chosen material. However, we were still able to demonstrate how the overall geometry of the muffler had an effect on the noise level of the scrubber. Since we used PVC pipe, it was difficult to find the exact diameter that we needed. We felt it was sufficient to round to the nearest whole number for testing purposes. As mentioned previously, the actual design will also be manufactured using the Rotomolding process.

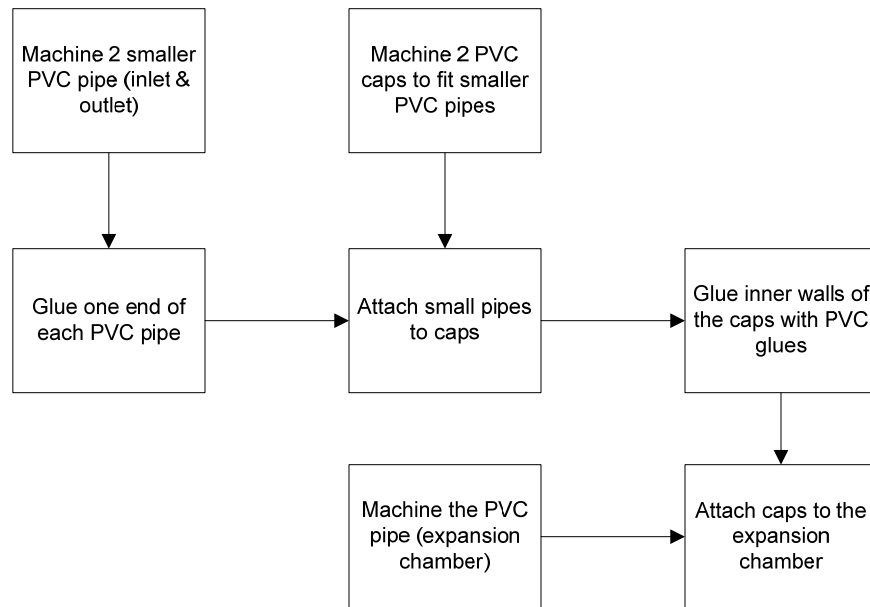

Figure 59 illustrates the assembly plan of the muffler.

12.3 Motor Insulation

There is no Fabrication involved in demonstrating this concept, we simply purchased R-13 Fiberglass insulation wool and packed it accordingly in the space around the motor. This process does not require any mass manufacturing; Tennant can purchase fiberglass wool in bulk and have it installed in their floor scrubbers.

12.4 Mid-section Seal

Similar to the motor insulation, we simply bought adhesive rubber lining to attach along the boundary since the current rubber lining used for testing purposes has started to wear out. The Motor Insulation and the Midsection seal prototype setup are exactly how we expect to have the materials installed in an actual retail floor scrubber.



Figure 60 shows the seal around the midsection

12.5 Isolation Mounts

We were provided by these mounts by Tennant Company these mounts over the internet with appropriate dimensions and installing them on the upper section of the motor where the bolts are located. We may need to test these mounts to determine how much noise has been controlled due to vibration in the motor.

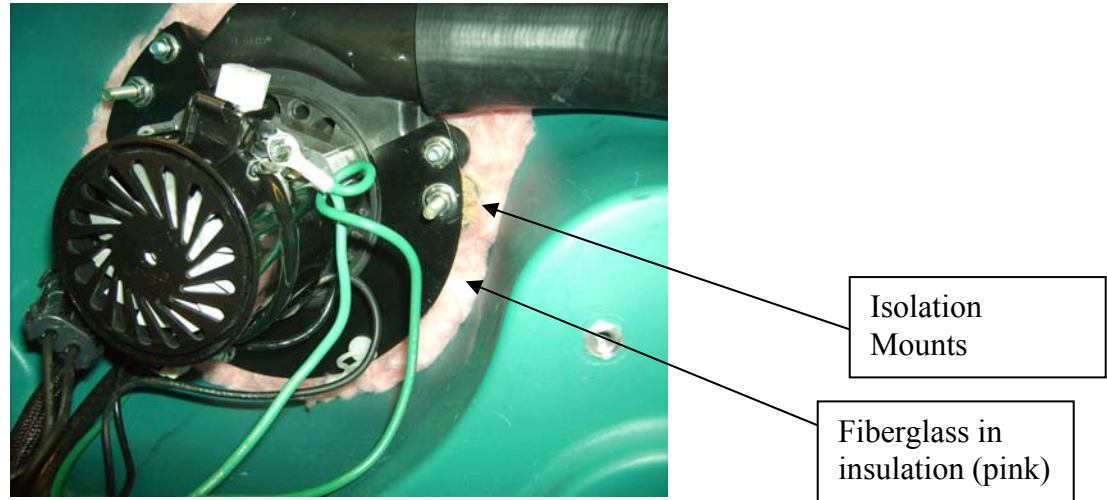

Figure 61 shows the fiberglass wool insulation around the motor

12.6 Active Noise Equipment

Initially we planned on purchasing an Active Noise cancellation device. More details about equipment and price are given in the appendix. The equipment that we planned on purchasing would not have fitted inside the recommended location. It was to demonstrate the effect of Active noise canceling. Due to the limitations on the product data available and performance rating our prototype kit wouldn't exhibit the design features and results based on our concept. The price of the noise canceling kit reflects its performance. Through a series of discussions with our instructors we decided not to demonstrate this feature in our prototype mainly due to time constraint. Presence of body vibrations would have a negative effect on the active noise control equipment. We were told that to demonstrate active noise control enormous testing and equipment calibration is required which would only be possible if we had access to testing equipment. However we are very confident about this concept and would recommend Tennant Company to further research on this idea in order to implement in their future floor scrubber designs.

13. VALIDATION APPROACH

To validate our design concepts, we relied on several testing procedures. Initially we tested each prototype individually to determine if its presence has any effect on sound level. Some of our prototypes did not fit inside the scrubber due to packing constraints. As a next step, we performed a combined prototype test for all the parts that do fit inside the machine well enough such as the motor insulation, isolation gaskets, and the seal.

Since most of designs are based on material selection and dimensions we were able to test for the limit set on Weight (≤ 9.07 kg), Volume (≤ 2.837 mm³). From our CAD model we were able to calculate the volume of our new designs. With all the materials listed under ‘Bill of Materials’ indicate that we have maintained our cost constraint. Some of the most challenging tasks would be the life span of the designed components and the overall noise reduction. We did not have the equipment to test for the fatigue life of the equipment and for the overall sound reduction we had to make an educated guess about it and make recommendations to Tennant about redesigning some of the exterior body parts to accommodate our concepts.

13.1 Muffler Design

In order to test for sound reduction in the floor scrubber, we needed to install the new muffler in place of the old one. We pulled the vacuum motor out of the mounts in order to do the testing since the polyethylene molding limited our space. We attached a rubber hose with 1” diameter to the outlet of the motor. To show the differences in noise levels, we first tested the vacuum motor without a muffler. We then tested the original muffler and the redesigned muffler with the vacuum motor.

Since we were not able to test with our intended material, we had to test with an alternate material. We used EPDM to insulate the inside of the muffler to test the effect of the material on sound reduction. The material change made a difference in testing since sound absorption is directly related to material properties. Even though we were not able to actually test the material, we feel that fiberglass will be the best choice. This material is shown to have a high noise reduction coefficient at the frequency of our motor. Since a higher noise reduction coefficient means higher sound absorption, we feel that this material will make a big difference in the noise level of the muffler.

	Ear Level	Inlet	Middle	Outlet
No Muffler	81	106	N/A	N/A
Original Muffler	75	88	89	87
New Muffler	74	85	84	84

Table 15 shows the results of the muffler validation

As shown in the table, the tests confirmed that the muffler helps in reducing the noise level by at least 1dBA. We used EPDM for insulation to demonstrate that proper insulation would have an effect on sound reduction.

We feel that the recommended materials in our final design description would help increase reduction. If the polyethylene mold was remanufactured to fit the newly designed muffler, it would have shown better results.

13.2 Elbow Pipe

After installing our prototype to the floor scrubber machine, we were not able to close the hood of the recovery tank due to the packing constraint. We attached the elbow to the stand pipe with the help of a mount. We insulated the inside of the elbow with EPDM. We performed tests with the original elbow design and compared it to the results from the newly designed elbow with the insulation and without. The results are summarized in the table below.

	Ear Level	Side
Original Elbow	77	83
Elbow without EPDM	76	79
Elbow with EPDM	75	78

Table 16 shows the results from the elbow validation

The elbow with the EPDM shows a 2dBA drop compared to the original elbow. There was also a large decrease in noise at the side of the floor scrubber.

We feel that if polyethylene and polyurethane were used, we would see even better results. Also, we recommend Tennant to remanufacture the lid to fit the new elbow. With the closed lid, we predict the floor scrubber to be considerably quieter.

To further advance our validation process, we decided to perform a spectrum analysis on our sound waveforms. The main purpose of doing this was to prove that even though we are not able to demonstrate an actual situation where sections of the floor scrubber would be properly intact and have our prototypes installed due to volume constraint, we decided to record the sound produced from the original and the prototype to compare them. To perform the experiment we installed the elbow pipe and the muffler (as shown below) and recorded sound at ear level position for about 10 seconds.



Figures 62 and 63 illustrate the experimental setup for waveform Analysis, the same setup was followed for the original design as well.

Two independent experiments were performed for the muffler and the elbow pipe to determine the impact of each design to the overall sound levels. The machine was operated and sound was recorded at operator ear level using a microphone that was connected to a computer. Operator ear level is a reference point where all measurements were performed, since our objective is to reduce noise that is detected at the operator's level. Sound waveforms were then converted into power spectrums to determine the energy levels of each sound sample. Two set of experiments were performed for the elbow pipe as well as the muffler. The sound waveforms for the elbow pipe are shown below:

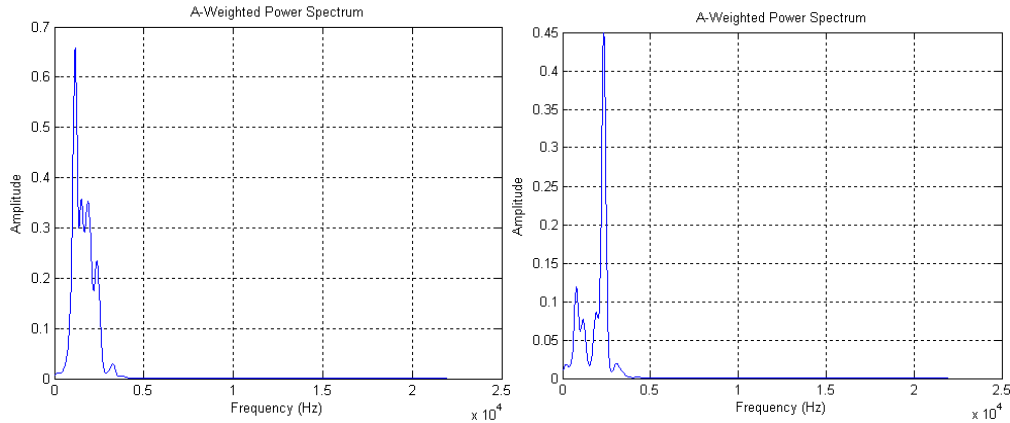

Figures 64 & 65 illustrate the dBA scale power spectrums for original & new elbow pipe

The above power spectrums show a range of sound energies for dBA scale for different frequencies. From the power spectrums we observe that maximum power amplitude of sound has decreased to almost half of its original. A lot of the major peaks have been reduced. The area under these spectrums is the sound intensity. Tabulated results are shown below:

	Max Amplitude (W)	Frequency (Hz)	Average Intensity (W/m²)	Frequency at which compared (Hz)	Amplitude at compared frequency (W)
Original Elbow	0.65	1160	28.25	-	-
New Elbow	0.44	2342	24.60	1160	0.077

Table 17 shows the results for the sound energy validation

From the above results we see that adding the new muffler has reduced the sound energy significantly. The major sound peak was compared by observing the amplitude of new elbow at the frequency that had the highest peak for the old elbow. A reduction of 88% is observed. Also the intensity level has significantly reduced. The same experimental procedure was carried out for the muffler. The following spectrums and results were observed:

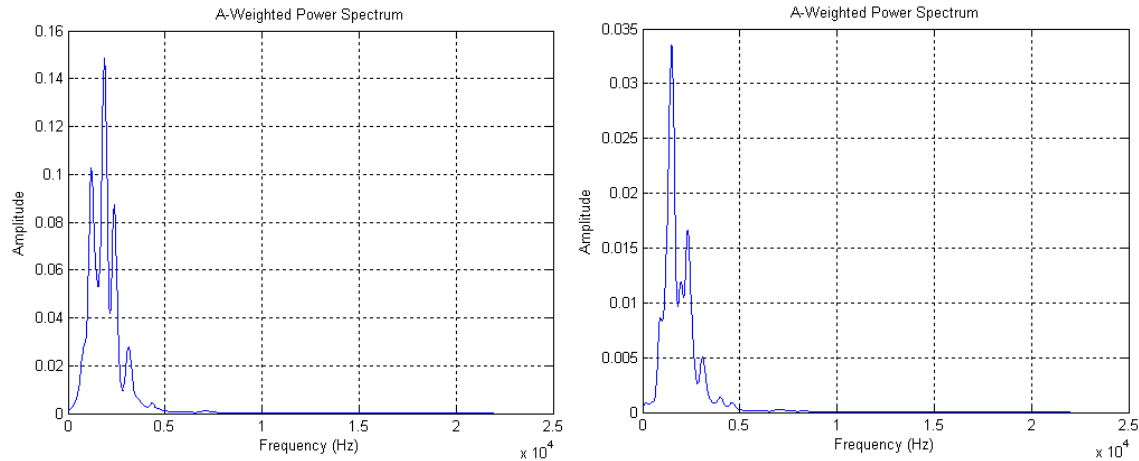

Figures 66 & 67 illustrates the dBA scale power spectrums for original and new muffler

	Max Amplitude (W)	Frequency (Hz)	Average Intensity (W/m ²)	Frequency at which compared (Hz)	Amplitude at compared frequency (W)
Original Muffler	0.15	1869	22.67	-	-
New Muffler	0.03357	1486	15.70	1869	0.011

Table 18 shows the results for the sound energy validation

From the above results we observe a significant drop in the energy levels, with sound intensity reducing by about 30%. From these two experiments and our previous experiments we are able to validate that the elbow and the muffler are definitely a feasible designs that would reduce noise by 3 dBA or more. Precise reduction of noise reduction under normal conditions cannot be made until some of the exteriors are re-manufactured to accommodate the new designs. more details on that are discussed in our recommendations section.

13.3 Seal, Isolation Mounts, and Motor Insulation

For the mid-section seal, isolation mounts and the motor insulation we simply had to package it within our floor scrubber and perform sound as well as frequency testing to compare with original data to compare the difference in results. We also created sound maps that included the seal, motor mounts and motor insulation. These tests were performed with the original muffler and elbow installed. There was a 3dBA decrease in sound level at the midsection of the floor scrubber and up to a 5 dBA drop in the front of the floor scrubber. The sound map below details more measurements around the floor scrubber.

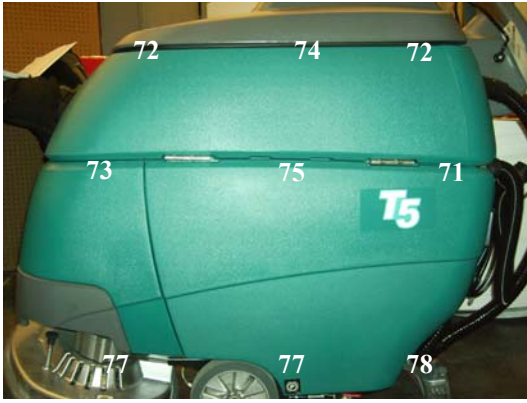

Figure 68 shows the sound maps after installing the seal, motor mounts, and isolator gaskets

14. DISCUSSION

After completing our design, we believe that some areas in the design process could have been improved. We felt that earlier research and testing would have helped us to pinpoint the locations of highest noise. Due to time constraints, we weren't able to do frequency analysis as much as we would have liked. We feel that if we had started taking frequency measurements earlier, the frequency analysis may have helped us in generating different concepts.

Due to lack of more sophisticated equipment, we feel that our design may lack the precision that would be helpful in further sound attenuation. With different equipment, we could have gotten more accurate results, which would then help us in generating concepts. Despite this, we believe that our designs will be easy to manufacture, which may help in minimizing manufacturing costs.

We observed from sound and frequency test results that noise within the recovery tank is contributing greatly to the overall noise level. We thought of possibly reducing this sound using water insulation pads and baffles. However, our sponsor suggested no alterations within the walls of the recovery tank due to the contact with water. While effectively cleaning the recovery tank is already a challenge, any additions would make cleaning even more difficult and enable fungus development which leads to bad smell. If granted more time, we would further investigate means of reducing noise in the recovery tank.

15. RECOMMENDATIONS

The redesigned components for the Tennant T5 floor scrubber have shown some promising results. While it met the customer and engineering requirements, there is still room for improvement.

15.1 Re-Manufacturing

To implement the new elbow pipe and muffler, remanufacturing of the recovery tank lid and the mid-section is required. The dimensions of the redesigned components are larger than what would fit inside the scrubber. Increasing the height of the lid body would make it possible to install the elbow pipe and close the lid. The midsection requires a larger indent to accommodate the expansion muffler. The current design is too small to fit any thing larger than the current exhaust muffler. The two redesigned components have produced positive results, thus implementing them in future machines would be definitely beneficial. Creating more volume due to component redesign would mean compromising the recovery tank volume. Tennant can tackle this issue by increasing the width of the machine by a couple of millimeters. From the market perspective, T5 is the quietest and most compact machine compared to its competitors. If Tennant can produce a floor scrubber that is even quieter and slightly bigger than the previous design, customers would likely be willing to pay the price for more comfort over size of the machine.



Figure 69 illustrates the current recovery tank lid that needs to be redesigned to accommodate the new elbow pipe.



Current Muffler indent in the mid-section

Figure 70 illustrates the current muffler indent that needs to be enlarged to accommodate the new design.

15.2 Experimental Testing

During product development, we recommend that Tennant use professional equipment for sound testing and measurements. Testing noise levels in a soundproof room, using pressure tubes and velocity sensors, would produce the most accurate results for sound level. Due to the inaccessibility of appropriate equipment, sharing testing lab with other teams, and lack of support from acoustics professionals, there were several discrepancies in our results. Therefore, to record most accurate results we had to perform the experiments numerous times before making a final judgment. This would prove very useful when redesigning the components and eliminate any possible errors.

15.3 Active Noise Control (ANC)

Active noise control is a highly effective technology for noise cancellation. From thorough research we found an inexpensive and highly effective solution. Careful attention needs to be given when installing this equipment. If the distance between its components is calculated incorrectly, it may have a negative effect and amplify sound even more. With the right set of testing equipment and multiple testing rounds, one can make this technology work as desired. Active noise control is a part of our final design concept. Due to constraint on time and technology, we weren't able to implement and test the equipment. More details about active noise control are discussed in the final design section.

This project can be further enhanced by refining the design concepts and passing our findings to the next batch of ME 450 individuals interested in working on noise reduction. In this manner the next set of students would not need to spend a lot of time of sound analysis and start focusing more on the design aspect of this project. Due to the complex nature of Active New Cancellation, an entire project can be devoted to designing and implementing this system into the floor scrubber.

16 SUMMARY AND CONCLUSIONS

The current Tennant T5 floor scrubber has a high noise level which needs reduction. We have been asked to redesign components to reduce noise while the machine operates optimally. Our design specifications and customer requirements have been met.

Sound tests were performed to determine the actual noise level and the major sources of noise. Although the motor was found to be the main source of noise, we decided to concentrate on other design attributes due to cost constraints. The other sources of noise identified were the muffler, scrubber mid-section and the water recovery tank. Numerous design concepts were generated, the final design concept is a combination of individual designs.

After testing our initial concepts, we concluded that these designs did not accomplish the goal. After further researching sound attenuation methods, we generated new concepts using engineering analysis. We also determined a fabrication plan to manufacture the prototypes, and then tested every prototype in the floor scrubber. After we tested these prototypes, we determined the designs that needed to be included in the final recommendations based on results and cost analysis.

The redesigned components met the requirements we were trying to achieve. Both the elbow pipe and the expansion muffler were prototyped. Furthermore, the installation of the fiberglass wool and mounts was prepared and displayed at the University of Michigan College of Engineering Design Expo on April 10th 2008. Through extensive testing, we determined that the elbow pipe and the expansion muffler each reduced noise by 1½ dBA, for a total of 3 dBA.

Another sound map was produced for the scrubber with installed insulation and mounts. This map was compared with the original sound maps that were generated when the machine was initially tested. The sound map comparison validated a significant drop in sound level, approximately 3dBA around the midsection and 5dBA in front of the machine. We further enhanced our validation process by performing a waveform analysis which generated power spectrums from recorded sound. We observed a 30% drop in sound intensity level in the presence of the elbow pipe and the muffler.

Our components were prototyped using polyvinyl chloride (PVC) piping with ethylene propylene diene monomer (EPDM) insulation. The midsection seal was also made from EPDM. We recommend manufacturing the elbow pipe with high density polyethylene and lining the inner wall with a polyurethane insulation. The muffler walls should be made from coiled polyethylene, surrounded by fiberglass wool with a noise reduction coefficient (NRC) rating of 0.20, instead of a metallic wire mesh. We maximized the length to diameter ratio of the elbow pipe and the muffler to obtain the best results.

Active noise control was tested using a pair of active noise canceling headphones. From lab testing we observed that the active noise cancellation (ANC) headphones reduced sound level by about 2dBA. More details can be found under Parameter Analysis for Active Noise Cancellation. This is the only design concept that was not implemented as a part of our prototype simply due to time constraints. Implementing ANC technology requires extensive testing and equipment calibration. We are confident that this technology would reduce noise significantly. For more details about the final design please refer to the section on ‘Final Design Description’ and the Appendix B for Engineering Design changes.

17. ACKNOWLEDGEMENTS

Dr. Lalit Patil (Section Instructor): For all his support and guidance during the course of the project. In a challenging project, his assistance has turned a design idea into a reality.

Mr. Fred Hekman from Tennant Company: For all his support and prompt assistance during the entire course of semester. We thank him for providing us with all the essential equipments ranging from the floor scrubber to even the smallest parts like washers and mounts. His support means a lot to all of us in succeeding in this project.

Bob Coury and Marvin R Cressey: For their providing instructions and recommendations in the machine during prototype manufacturing.

18. REFERENCES

- [1] David W. Wood, Rockford; Donald J. Legatt, St. Michael; William F. Allen, Wayzata, Automatic Floor Scrubber. U.S Patent 5,369,838, Dec. 6, 1994.
- [2] Kellermeyer Minuteman 320
<http://www.kellermeyer.com/equipment/MM320.htm>
- [3] Advance Warrior ST & AXP
http://www.advance-us.com/Products/Commercial/AutomaticScrubbers/WarriorST_AXP.aspx
- [4] Tennant T5
<http://www.tennantco.com/na-en/products/machines/t5-scrubber.aspx>
- [5] Conrad J. Hemond, Jr., Excerpt from '*ENGINEERING ACOUSTICS AND NOISE CONTROL*', 1983 by Prentice-Hall.
- [6] Kang, Assembly for a Vacuum Cleaner having a sound-absorbing system, U.S. Patent 5,471,707 Dec. 5, 1995
- [7] Fischer, Noise Suppressor for Vacuum sweepers and the like, U.S. Patent 4,418,443 Dec. 6, 1983.
- [8] VBD-10 Dampening Compound
http://www.acousticalsolutions.com/datasheets/data_compound.asp
- [9] Christopher E. Ruckman, Active Noise Control FAQ,
<http://www.chrisruckman.com/ancfaq.htm>
- [10] "*Active Noise Control Primer*", Scott D. Snyder, Department of Mechanical Engineering, University of Adelaide, 2000 Springer-Verlag New York.
- [11] <http://www.technofirstamerica.com/>
- [12] "*Active Fan Blade Noise Cancellation System*" by Guerci, Patent # 5,448,645, Date of Patent Sep 5. 1995.
- [13] Texas Instruments: Active Noise Cancellation(ANC):
<http://focus.ti.com/vf/docs/blockdiagram.tsp?family=vf&blockDiagramId=6048#>
- [14] Silentium ANC:Review, Alon Slapak, Aug 2007
- [15] Tennant Company Resource Information
- [16] www.eagleledesign.com

[17] Cambridge Engineering Selector (CES)

[18] www.homedepot.com

[19] Destructive Interference

<http://www.glenbrook.k12.il.us/GBSSCI/PHYS/Class/waves/u10l3c.html>

[20] Daniel R. Raichel, Excerpt from ‘*The Science and Applications of Acoustics.*’ 2000 by Springer

19. BIOS



Arsalan Ahmed is a senior in Mechanical Engineering also pursuing a minor in Mathematics at the University of Michigan, Ann Arbor. Pakistani by origin, Arsalan was born on October 2nd 1986 and brought up in Dubai, United Arab Emirates. He plans on moving back to Dubai after graduation in April 2008 to get involved in his father’s business. In the future, he plans on pursuing a degree in MBA.

Previously served as the publicity chair of American Society of Mechanical Engineers, Arsalan is currently involved in Muslim Engineering Students Association (MESA) a small semi social/professional organization here on north campus.

One of the main reasons that drove him into mechanical engineering is the academic diversity. He believes that mechanical engineering is a multi disciplinary field giving the student the independence to learn many different technical skills ranging from mechanics, thermal sciences, manufacturing to all the way to control engineering which happens to be his favorite subject. In his free time he enjoys playing soccer or debating with his brother on random topics. Since he does not enjoy reading he would rather watch television news or documentaries to keep him updated with current affairs.



Pratyusha Devarakonda: I was born in India on March 14, 1987. I attended school in India for a few years and then moved to Warren, MI. In 11th grade, I moved again to Novi, MI where I finished high school. I am currently a senior in mechanical engineering. After graduation, I am going to be working for ArcelorMittal in Indiana.

I wanted to always go to Michigan because I grew up a Wolverine fan. I love living in Ann Arbor and I am going to deeply miss it when I move away. I love to dance; I participated in the Indian American Student Association’s cultural show for three years. I also like to read fiction and play tennis whenever I get a chance.



Priyanka Sohani: I was born in Jodhpur, India on November 28, 1986. I moved to Michigan when I was one. After briefly moving to California when I was six, my

family moved to Novi, MI where I have been living since the third grade. Growing up, I always loved to read and enjoyed playing different sports such as gymnastics and tennis.

University of Michigan was my first choice when applying to college. I first started out college as an LS&A student, but then transferred into the engineering school after my freshmen year to pursue mechanical engineering. I am currently a senior and will be graduating in April. I am still unsure of my future plans after college but would like to get a job.



My name is Bronson Edwards and I grew up in Atlanta, GA. I am a part of the Atlanta University Center (AUC) Dual Degree Engineering Program. This program allowed me to attend Morehouse, a historically black college for three years prior to attending the University of Michigan (UM). I will graduate with a degree from Morehouse in Applied Physics and the University of Michigan in Mechanical Engineering. As a Georgia resident, it was assumed that I would attend the Georgia Institute of Technology. However, I wanted to be a part of only the second cohort to transfer to UM and help develop an association between the AUC and UM that would only grow stronger. I have been blessed to intern with NASA, MIT, and even the Baosteel Corporation in Shanghai, China. Upon graduation in December 2008, I plan to enhance my engineering and leadership skills working in industry in preparation for a top MBA program.

20. APPENDIX A

20.1 QFD

1	Additional Maximum Weight															
2	Additional Volume*	9														
3	Machine Operating Temperature*															
4	Sound Level*		1	3												
5	Lifespan	3	9	3												
6	Motor Power															
7	Cart Speed	3			1			1								
8	Productivity						1		3	3						
9	Manufacturing Time		3													
10	Retail Price*	9	1		9	3	3				9	9				
Technical Requirements																
Customer Needs		Customer Weights	Additional Maximum Weight	Additional Volume*	Machine Operating Temperature*	Sound Level*	Lifespan	Motor Power	Cart Speed	Productivity	Manufacturing Time	Retail Price*	Benchmark Evaluations			
			Advance Warrior	Minuteman 320												
1	Durability	4	1	3	9	9	9	1			3	9	4	5		
2	lower noise level*	9	3	3		9	3	3		3			3	2		
3	easily replacable	2					3				9	9	N/A	N/A		
4	want to optimize water tank size	6	3	9		1				9	3	3	4	3		
5	maintain overall scrubber size	4	9	9		9			1	3	1	1	4	5		
6	must be light weight	2	9	9		1			9	9			9	4	5	
7	plastic material	5	3		9	9	1		1			3	4	4		
8	ergonomics/aesthetics	3	3	9		9					1	9	4	1		
9	long life span	7			9	1	9	1				3	N/A	N/A		
10	bulk production	5		1							9	9	N/A	N/A		
11	Affordable*	8	1	3		9				9		9	4	4		
12	controlled operating temperature	7			9		9	3					N/A	N/A		
13	Self Propelled	1	3			9		3	3	1	1	9	5	3		
		Raw score	138	203	207	321	200	62	111	184	101	283				
		Scaled	0.43	0.63	0.64	1	0.62	0.19	0.35	0.57	0.31	0.88				
		Relative Weight	8%	11%	11%	18%	11%	3%	6%	10%	6%	16%				
		Rank	7	4	3	1	5	10	8	6	9	2				
Technical Requirement Units			lbs	ft3	°F	dB	hrs	hp	mph	ft2/hr	days	\$				

20.2 Gantt Chart

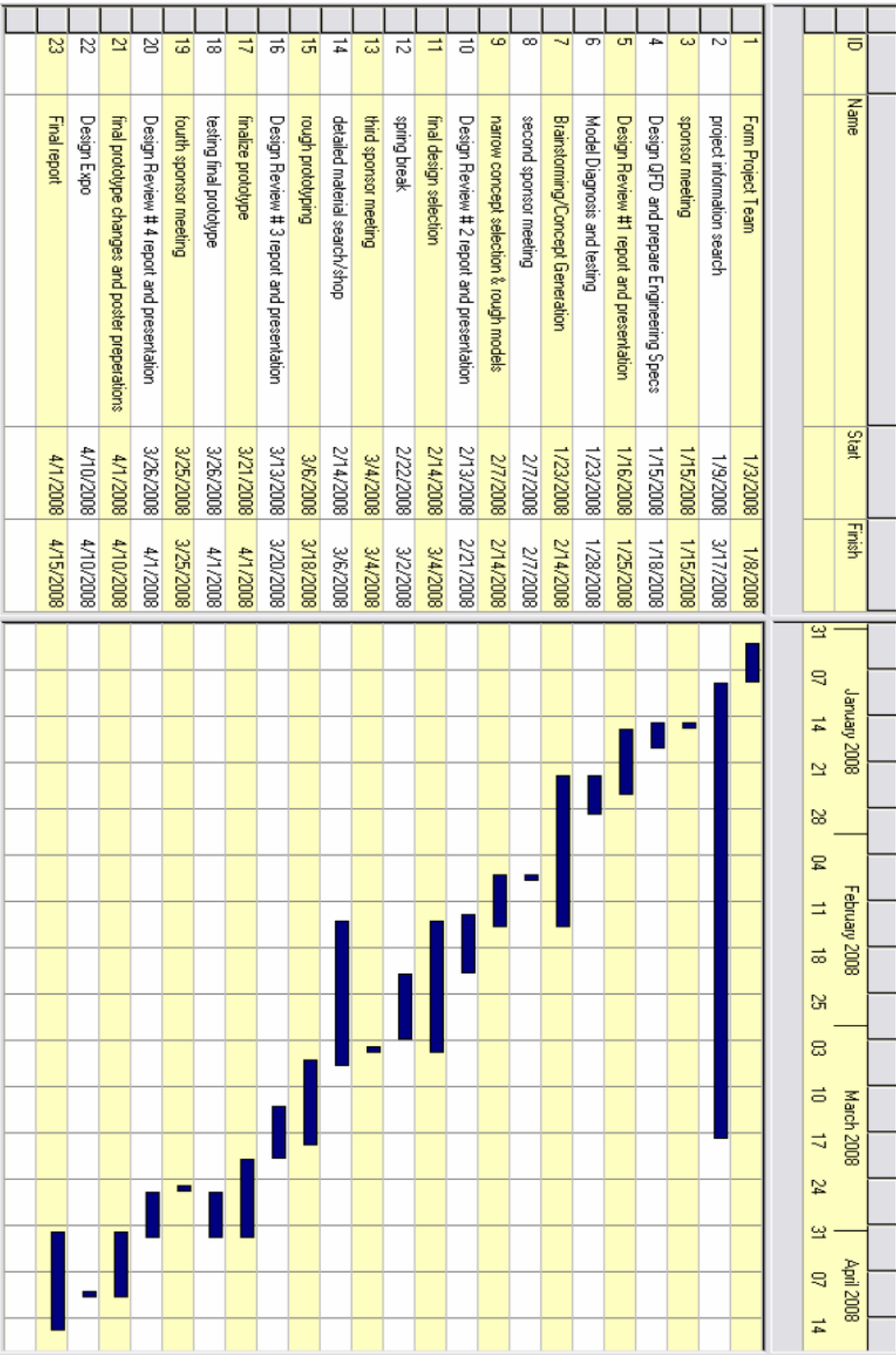

21. APPENDIX B

21.1 Motor Fan Cover

Concept 1: As shown in Figure 20 (a), the cover has slits on the bottom. The cover would be made with polyethylene so that it is strong and it is heat resistant. The cover would also be lined with pyramid surface foam for sound attenuation.

Concept 2: As shown in Figure 20 (b), the cover would have rectangular slits on the side to allow air flow for the fan. It would also be made with polyethylene but lined with polyvinyl foam.

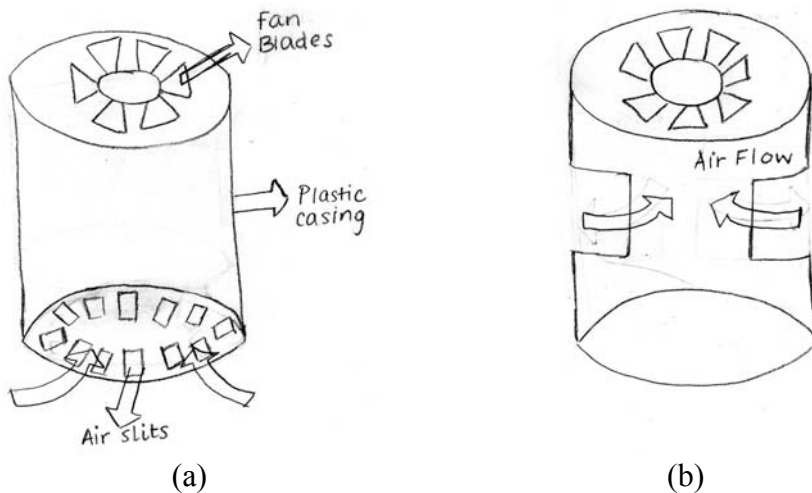

Figure 71 shows the Concept Sketches for the Motor Fan Cover







Subfunction	Subfunction Concepts			
Absorb through geometry	 Pyramid surface	 Triangular surface	Square Opening	Oval Opening
Absorb through material	 Closed cell	Natural cotton fiber acoustic insulation 	 Polyvinyl foam	 Fiberglass Insulation batting
Heat sensitivity	Polyethylene	Aluminum 		
Allow air flow	Rectangular opening through the side	Rectangular slits on the bottom	Triangular slits on the bottom	Circular slits on the bottom

Table 19 shows the Concept chart for the motor fan cover

Pyramid surface (mattress pads), Closed cell, Polyethylene, Rectangular opening through the side	Triangular surface, Natural cotton fiber acoustic insulation, Aluminum, Rectangular slits on the bottom	Square Opening, Original foam, Aluminum, Triangular slits on the bottom	Square Opening, Closed cell, Rectangular opening through the side, Rectangular opening through the side	Pyramid surface (mattress pads), Closed cell, Aluminum, Rectangular slits on the bottom
Triangular surface, Closed cell, Polyethylene, Rectangular opening through the side	Square Opening, Natural cotton fiber acoustic insulation, Aluminum, Rectangular slits on the bottom	Pyramid surface (mattress pads), Polyvinyl foam, Polyethylene, Rectangular slits on the bottom	Oval Opening, Closed cell, Polyethylene, Rectangular opening through the side	Pyramid surface (mattress pads), Closed cell, Aluminum, Triangular slits on the bottom
Oval Opening, Natural cotton fiber acoustic insulation, Rectangular slits on the bottom, Rectangular slits on the bottom	Pyramid surface (mattress pads), Closed cell, Aluminum, Circular slits on the bottom	Triangular surface, Natural cotton fiber acoustic insulation, Aluminum, Circular slits on the bottom	Triangular surface, Natural cotton fiber acoustic insulation, Aluminum, Triangular slits on the bottom	Triangular surface, Natural cotton fiber acoustic insulation, Aluminum, Circular slits on the bottom

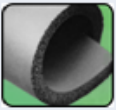
Cont'd Table 19 illustrates the concept generation for the motor fan cover

21.2 Muffler Concept Generation

Varying internal diameter, Closed cell foam	Increase length, Natural cotton fiber acoustic insulation	Decrease length, Mineral fiber	Change the direction of the flow, Fiberglass Insulation batting
Varying internal diameter, Natural cotton fiber acoustic insulation	Increase length, Closed cell foam	Decrease length, Closed cell foam	Change the direction of the flow, Closed cell foam
Varying internal diameter, Mineral fiber	Increase length, Mineral fiber	Decrease length, Natural cotton fiber acoustic insulation	Change the direction of the flow, Natural cotton fiber acoustic insulation
Varying internal diameter, Fiberglass Insulation batting	Increase length, Fiberglass Insulation batting	Decrease length, Fiberglass Insulation batting	Change the direction of the flow, Mineral fiber

Table 20 illustrates the detailed concept generation for the muffler

21.3 Muffler Engineering Analysis

To find the speed of sound, c , we used equation 1. T is the temperature in degrees Celsius. The next step was then to find the wavelength, λ , at a certain frequency, f , shown in equation 2.

$$c = 20.04\sqrt{T + 273.16} \quad \text{Eq.[1]}$$

$$\lambda = \frac{c}{f} \quad \text{Eq.[2]}$$

We then found the optimal length of the expansion chamber by using equation 3. We assumed a transmission loss (TL) of 10 decibels. The expression Ω defines the ratio of the cross sectional area of the expansion chamber, B , to the cross sectional area of the inlet/outlet pipe, A . B/A was solved for by using the quadratic formula. We then found B because the area of the inlet pipe is known. After determining the cross sectional area of the expansion chamber, we could then solve for the diameter of the chamber, d . [20]

$$C = \frac{\lambda}{4} \quad \text{Eq.[3]}$$

$$\Omega = 2(10^{TL/10} - 1)^{1/2} \quad \text{Eq.[4]}$$

$$\frac{B}{A} = \frac{\Omega + \sqrt{\Omega^2 + 4}}{2} \quad \text{Eq.[5]}$$

$$B = A * \frac{B}{A} \quad \text{Eq.[6]}$$

$$B = \frac{\pi d^2}{4} \quad \text{Eq.[7]}$$

21.4 CAD Drawing and Illustrations

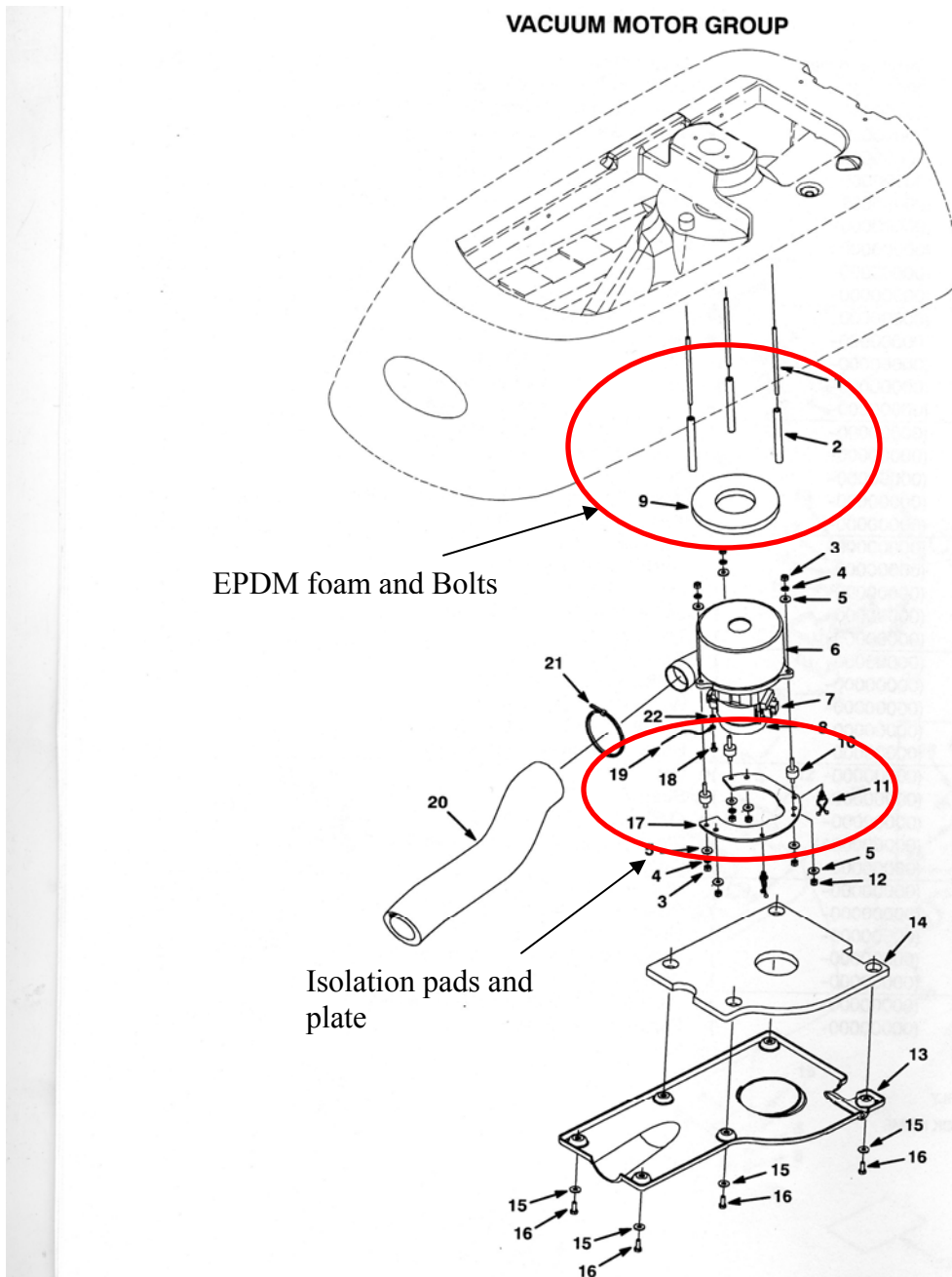
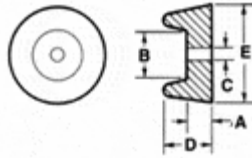

Figure 72 exploded view of the upper section of floor scrubber with isolation pads and bolts.

Mounting Feet



Recommended Maximum	Bolt Flg. Height	Bolt Flg. Diam.	Inside Diam.	Overall Height	Outside Diam.
15.0	0.270	0.493	0.123	0.521	0.982

Figure 73 shows dimensions of the isolations pads recommended for vibration control

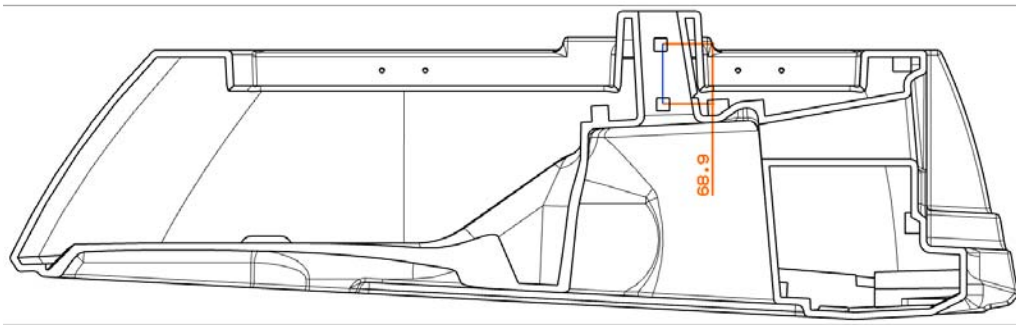
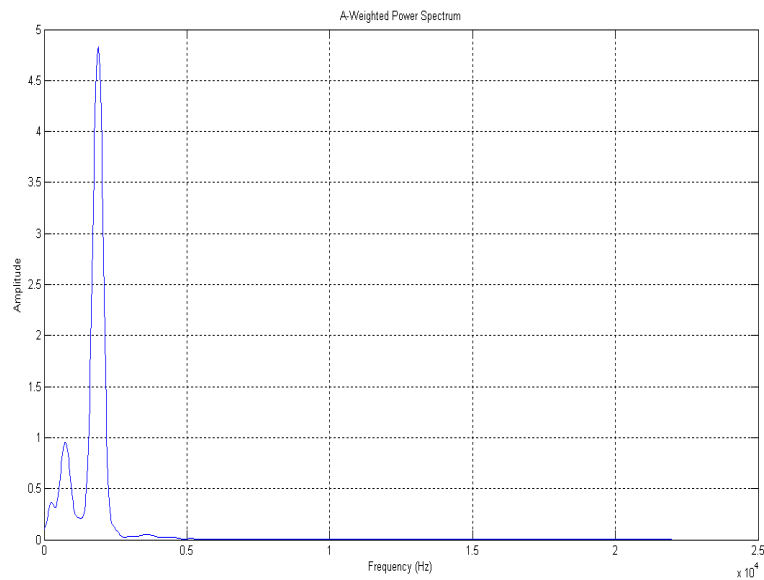
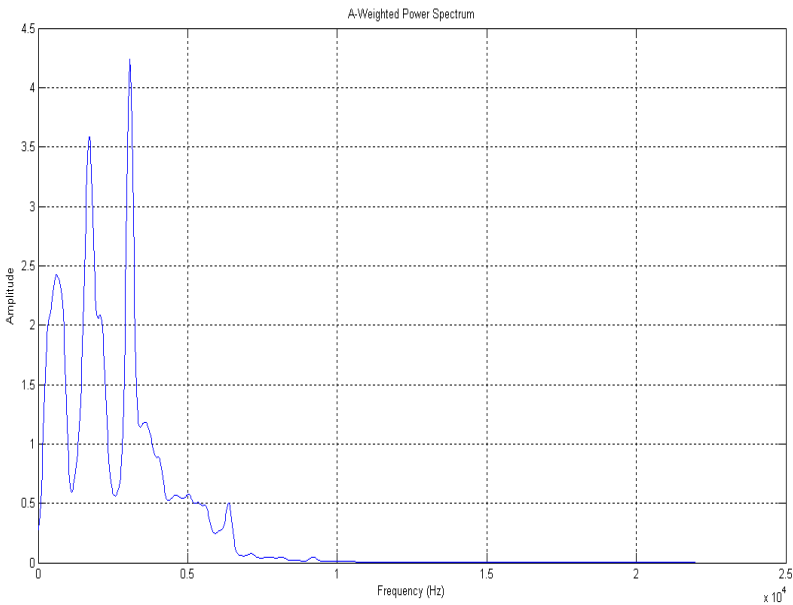
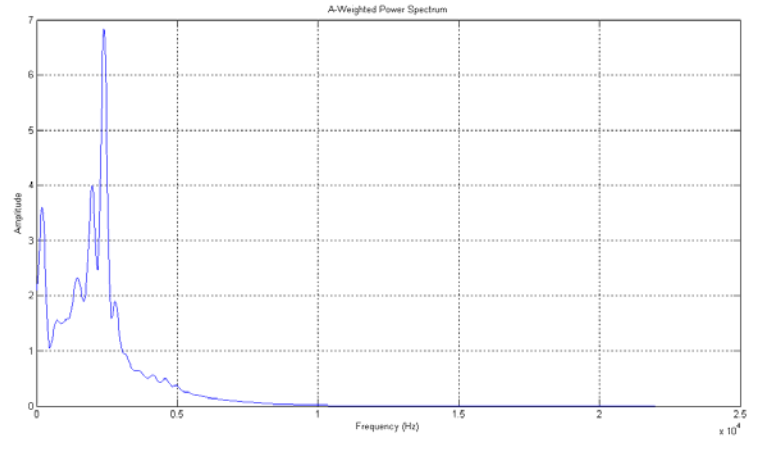
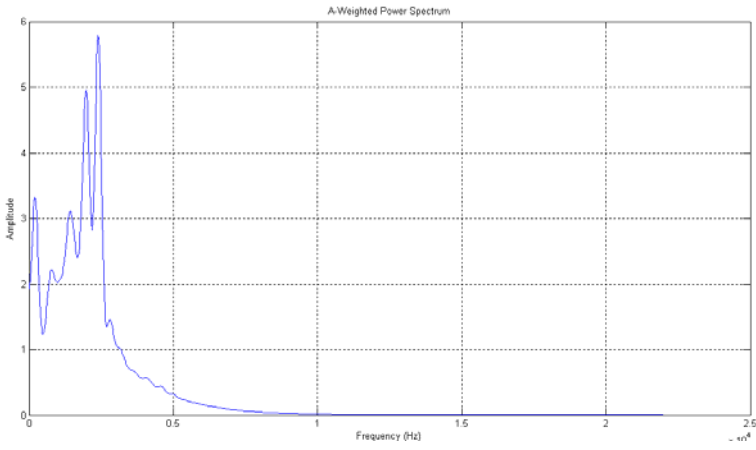

Figure 74 shows the side cross-sectional view of the recovery tank indicating the distance(mm) of the position where the reference microphone and the speaker is to be placed.



Figures 75& 76 show dBA spectrums for fan noise with and without noise cancellation respectively.



Figures 77 & 78 shows dBA spectrums for recovery tank with and without noise cancellation respectively.

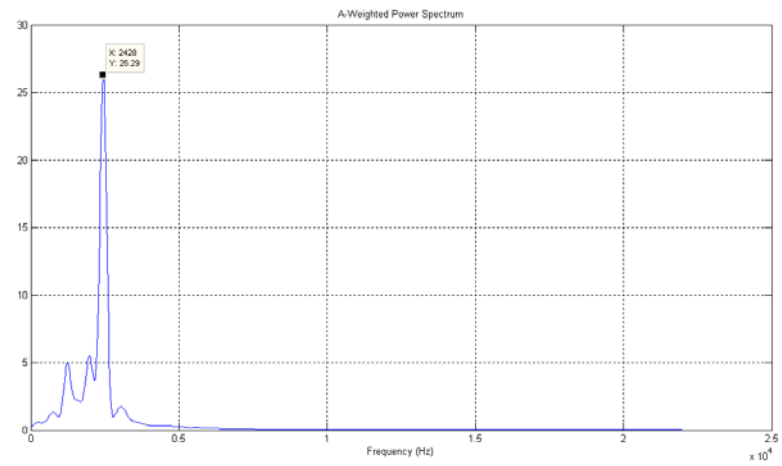
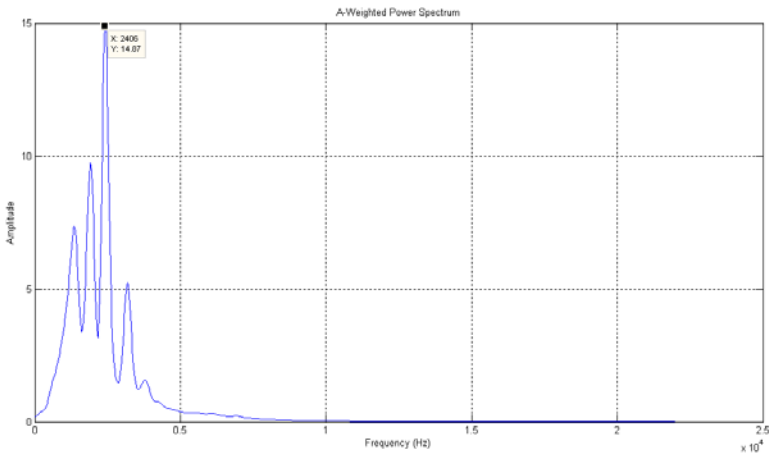

Figures 79 & 80 shows dBA spectrums for recovery tank with and without elbow pipe

22. APPENDIX C

22.1 Bill of Materials

Part #	Part Name	Qty	Material	Color/ Finish	Size	Mass (gms)	Function	Purchased from	Price	Shipping	Total(tax inclusive)
HA-NC 100	JVC Noise Cancelling headphones	1	-	black	-	907.18	Noise Control	amazon.com	\$51.14	\$6.00	\$60.20
139697	R-13 craft continous roll	1	fiberglass	pink	3720000 mm ²	2000	Thermal & Noise insulation	Home Depot	\$9.35	0	\$9.91
2550	Insulation Rubber Seal	2	EPDM	brown & white	6.57E4 mm ²	-	Noise Control	Home Depot	\$13.18	0	\$13.97
MP-2C	Rubber-Cork Anti-Vibration Pad	3	Rubber and Cork	black & brown	59400 mm ³	-	Vibration Isolation	Builders Plumbing Supply	\$1.06	0	\$1.12
PVC 2X10	2" PVC Pipe	1	PVC	White	6.17E6 mm ³	-	Noise Control	Builders Plumbing Supply	\$5.91	0	\$6.26
PVC 290EL	PVC Elbows	3	PVC	White	158 mm	-	Connect Pipes	Builders Plumbing Supply	\$1.50	0	\$1.59
PVC 4X10	4" PVC Pipe	1	PVC	White	24700000 mm ³	-	Noise Control	Builders Plumbing Supply	\$15.50	0	\$16.43
PVC 4CA	PVC Caps for 4" pipes	2	PVC	White	106 mm	-	Pipe covering	Builders Plumbing Supply	\$7.82	0	\$8.29
50CTGL OVES	Disposal Gloves	1	rubber	White	-	-	safety/handling fiberglass	Home Depot	\$3.97	0	\$4.21
-	Caulk Gun	1	aluminum	blue	-	-	Test Equipment	Home Depot	\$1.97	0	\$2.09
1684	Washer,Flat,0.25 Ss	4	aluminum	silver	-	-	Bolt attachment	Tennant	\$0.00	0	\$0.00
11329	Screw, Hex	2	aluminum	silver	45 mm	-	Elbow attachment	Tennant	\$0.00	0	\$0.00
1022406	Tube	3	steel	silver	8291 mm ³	-	Bolt attachment	Tennant	\$0.00	0	\$0.00
100038	EPDM W/Psa Foam sheets	10	EPDM	black	-	-	Noise Insulation and Vibration Isolation	Tennant	\$0.00	0	\$0.00
390677	Muffler Exhaust	1	EPDM,Vinyl	black	431.8 mm	-	Test Equipment	Tennant	\$0.00	0	\$0.00

OPA 2134	Operational Amplifier (Pre-Amplification)	1	Plastic/Copper	black	-	-	Active Noise Control	Texas Instrument	\$1.10	\$5.00	\$6.47
TPA 6203A1	Power Amplifiers	1	Plastic/Copper	black	-	-	Active Noise Control	Texas Instrument	\$0.45	-	\$0.48
TLV320A IC23B	Audio Codec	1	Plastic	-	25 mm ²	-	Active Noise Control	Texas Instrument	\$3.75	-	\$3.98
DAC5571	Digital to Analog Convertor	1	Plastic/Copper	black	-	-	Signal Conversion	Texas Instrument	\$1.15	-	\$1.22
TMS320 VC5502	Digital Signal Processor	1	Plastic/Copper	-	-	-	Signal Processing	Texas Instrument	\$7.50	-	\$7.95
										Total	\$144.17

PLEASE NOTE: If different Items are ordered from the same company the total shipping cost is only added to one of the components

22.2 Process Plan Sheets

Part Name: Elbow Pipe

Material Stock: 2" x 10' PVC pipe and Two 90° PVC elbows connecting pipe

No.	Process	Machine	Speed (rpm)	Tool	Fixture
1	Cut 12.6" of PVC Pipe	Bandsaw	75	Saw Blade	Vise
2	File rough edges	-	-	Fine Sand Paper	Stand Vise
3	Apply PVC glue solvent inner walls of elbows	-	-	-	-
4	Attach PVC elbow connections to both ends of pipe	-	-	-	-

Part Name: Elbow Pipe Holder

Material Stock: PVC flat stock 1" x 5" x 6"

No.	Process	Machine	Speed (rpm)	Tool	Fixture
1	Mark center of 5" x 6" PVC block	Marker	-	-	-
2	Mount PVC pipe for drilling hole	Lathe	-	-	Chuck
3	Adjust Chuck tightness to ensure constant distance from tool edge	Lathe	-	-	Chuck
4	Bore a 1" hole through center of PVC block	Lathe	250	1" Drill Bit	chuck and drill mount
5	Remove Drill bit and place boring tool stock on the hole edge	Lathe	-	boring tool stock	chuck
6	Bore hole to 1.73" diameter (Same as diameter of stand pipe)	Lathe	250	boring tool stock	chuck
7	Remove Boring tool and replace with cutting tool	Lathe	-	cutting tool	chuck
8	cut/reduce outer diameter of hole to 2" ensuring a snug elbow fit	Lathe	250	cutting tool	chuck
9	cut 1" deep from top of block to create cylinder with 2" outer diameter	Lathe	250	cutting tool	chuck
10	locate center of cylinder/hole and reset digital readout	Mill	-	center gauge	chuck
11	replace center gauge with 1" drill bit	Mill	-	1" drill bit	chuck
12	Drill 1" holes 1" in x-dir on both sides of the cylinder	Mill	400	1" drill bit	chuck
13	file corners of elbow pipe holder base	-	-	Coarse File	Stand Vise

Part Name: Expansion Muffler

Material Stock: 4" x 10' PVC Pipe, 1.8" PVC pipe and 2 PVC Caps for 4" Diameter pipe

No.	Process	Machine	Speed (rpm)	Tool	Fixture
1	Cut 14.4" of PVC Pipe of 4" diameter	Bandsaw	75	Saw Blade	Vise
2	File rough edges	-	-	Fine Sand Paper	Stand Vise
3	Cut two 1.8" diameter PVC pipes to length	Bandsaw	75	Saw Blade	Vise

4	Mount PVC cap for drilling hole	Lathe	-	-	Chuck
5	Adjust Chuck tightness to ensure constant distance from tool edge	Lathe	-	Cutting tool	Chuck
6	Bore a 1" hole on the center of the cap	Lathe	200	1" Drill Bit	chuck and drill mount
7	Replace Drill bit and place cutting tool stock on the hole edge	Lathe	-	Cutting tool stock	chuck
8	Enlarge hole close to 1.8" diameter to give a tight fit with a 1.8" pipe	Lathe	200	Cutting tool stock	chuck
9	Repeat same Process for another cap				
10	Apply PVC glue solvent on inner walls of 1.8" pipes and 4" caps	-	-	-	-

23. APPENDIX D

23.1 Description of Engineering Design Changes

During the prototyping stage of this project, there were a couple of design changes that we decided to implement that would make our amended final design perform more efficiently and be physically durable. The Engineering Design changes are listed below:

Description of Change

Length of the elbow pipe: The length of the elbow pipe in the recovery tank was increased from 280.8 mm to 320.04 mm.

Was:

Is:

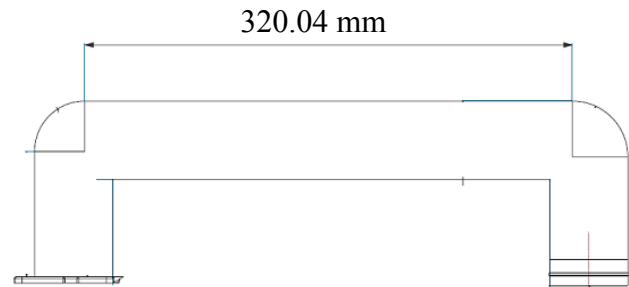
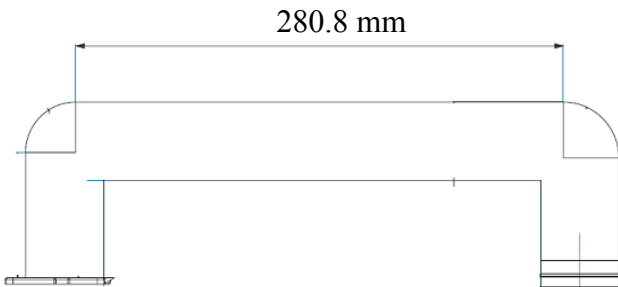

Reason for Change:

To maximize the sound reduction within the recovery tank. Sound travels longer distance thus attenuating more.

Personnel:

Change creator: Arsalan Ahmed

Change Approver: Pratyusha Devarakonda, Bronson Edwards, Priyanka Sohani

Authorized change date: 3/25/08

Description of Change

Introduced Elbow pipe mount: Elbow pipe is placed on top of the mount which is connected to the recovery tank

Was:
No Design Implemented

Is:

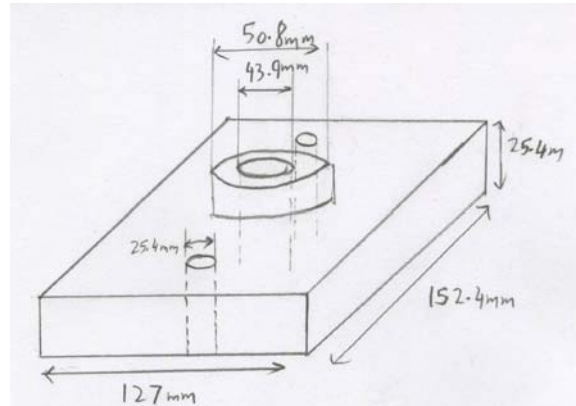

Reason for Change:

To connect the elbow pipe with the recovery tank and provide more structure stability to prevent the pipe from tipping over when placed on top of the recovery tank.

Personnel:

Change creator: Bronson Edwards

Change Approver: Pratyusha Devarakonda, Arsalan Ahmed, Priyanka Sohani

Authorized change date: 3/25/08

Description of Change

Change of Material: Wire mesh design for the muffler has been changed to coiled wire design made from polyethylene plastic.

Was:



Is:



Dimensions remain unchanged, material changed

Reason for Change:

Use of metal would increase the noise, polyethylene absorbs sound better.

Personnel:

Change creator: Mr. Fred Hekman

Change Approver: Pratyusha Devarakonda, Arsalan Ahmed, Priyanka Sohani, Bronson Edwards

Authorized change date: 3/28/08

Description of Change

Eliminated bottom plate of Elbow pipe: Bottom support plate for the elbow pipe was eliminated and replaced with a support mount.

Was:

Is:

Design Eliminated

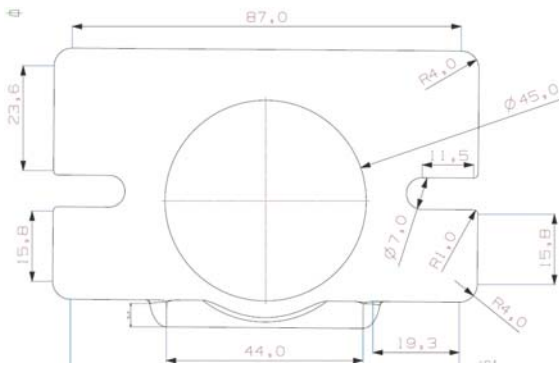

Reason for Change:

Design too weak to support the weight of the elbow pipe. Elbow pipe was likely to tip over.

Personnel:

Change creator: Arsalan Ahmed

Change Approver: Pratyusha Devarakonda, Bronson Edwards, Priyanka Sohani

Authorized change date: 3/26/08

24. APPENDIX E

After discussion with our GSI, we selected one component of our design for material selection and further analysis. We chose to analyze the elbow design.

24.1 Cambridge Engineering Selector (CES)

Insulation

For the insulation in the elbow, our main objective was to find a material with good sound absorbing qualities. The material had to be able to withstand temperatures up to 140°F, since this is the maximum operating temperature of the floor scrubber. We also wanted to keep the cost as low as possible, so we kept the limit at a maximum of \$5/lb. From these restrictions, we narrowed our options to 63 out of 112. Since our usage is primarily for sound absorption, we were then able to select materials according to their common uses. As shown below, sound insulation shows only 5 results. With our previous constraints, combined with the common uses, only melamine foam and polyurethane foam could be used in our application. We recommend using polyurethane because it was less costly.

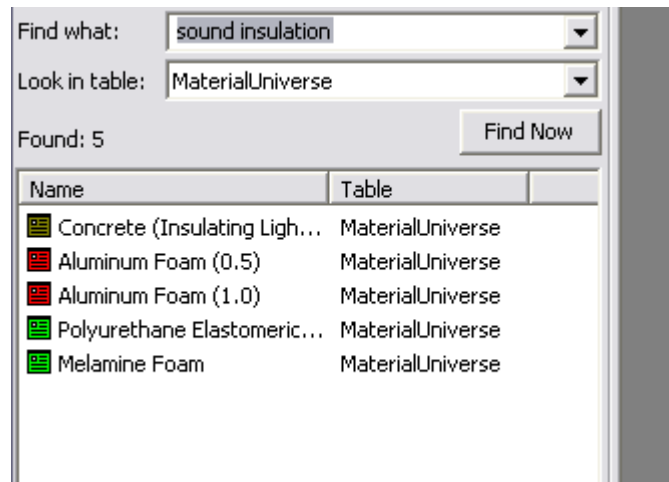

The screenshot shows the Cambridge Engineering Selector (CES) interface. The search criteria are 'Find what: sound insulation' and 'Look in table: MaterialUniverse'. The results show 5 items found. The results are as follows:

Name	Table
Concrete (Insulating Ligh...	MaterialUniverse
Aluminum Foam (0.5)	MaterialUniverse
Aluminum Foam (1.0)	MaterialUniverse
Polyurethane Elastomeric...	MaterialUniverse
Melamine Foam	MaterialUniverse

Figure 81 shows results for insulation analysis

Casing

For the outer casing of the elbow, we had similar constraints as described above. The maximum operating temperature remained 140°F. Since plastic materials tend to be less expensive to manufacture, we were able to limit our cost to \$1/lb. We also wanted to choose a material that would be recyclable. Our top choices are shown in the figure below. For comparison purposes, we chose to use high density polyethylene and propylene because they were most commonly used for our purposes. We recommend high density polyethylene because it is already used by Tennant and it would be easier for them to manufacture.

- ABS (Medium-impact, Injection Mol...)
- ABS (Rubber Modified, Injection M...)
- EVA (12% Vinyl acetate, Shore A9...)
- EVA (25% Vinyl acetate, Shore A85)
- EVA (33% Vinyl acetate, Shore A65)
- PBT (General Purpose)
- PE (High Density, High Molecular ...)
- PE (High Density, Homopolymer)
- PE (High Density, Low/Medium Mol...)
- PE (Low/Medium Density, Branche...)
- PE (Low/Medium Density, Linear C...)
- PET (unfilled, amorphous)
- PET (unfilled, crystalline)
- PP (65-70% barium sulfate)
- PP (Copolymer, 20% calcium carb...)
- PP (Copolymer, 30% calcium carb...)
- PP (Copolymer, 30% talc)

Figure 82 shows results for casing analysis

24.2 Design for Assembly (DFA)

DFA helps us in reducing the number of parts used in our design and reduce assembly time in order to improve efficiency. Since we had multiple designs we chose one specific design to focus on. Our selected design is the Elbow pipe. Using the DFA charts we were able to determine the assembly efficiency of our current design. To calculate the Assembly efficiency the following equation was applied:

$$AssemblyEfficiency = 3\left(\frac{N_m}{T_m}\right) \quad (Eq \#\#)$$

Assuming that each part takes 3 seconds to assemble.

DFA for original design

1	2	3	4	5	6	7	8	9	
Part ID No.	Number of times the operation is carried out consecutively	two digit manual handling code	manual handling time per part	two digit manual insertion code	manual insertion time per part	operation time,sec (4+6)*2	operation cost, cents (0.4*7)	figures for estimation of theoretical minimum parts	Name of Assembly: Elbow
1	1	30	1.95	98	9.0	21.9	8.76	1	recovery tank
2	1	20	1.8	00	1.5	6.6	2.64	0	elbow mount
3	1	30	1.95	30	2	7.9	3.16	1	elbow pipe (w/ 90s)
4	1	10	1.5	30	2	7	2.8	1	float
5	2	10	1.5	38	6	15	6	0	screw
						58.4	23.36	3	Design Efficiency (%)
						T _m	C _m	N _m	15.41

T_m: Actual assembly time in seconds
 C_m: Total Operation Cost
 N_m: Theoretical min. number of parts

DFA for New Design

1	2	3	4	5	6	7	8	9	
Part ID No.	Number of times the operation is carried out consecutively	two digit manual handling code	manual handling time per part	two digit manual insertion code	manual insertion time per part	operation time,sec (4+6)*2	operation cost, cents (0.4*7)	figures for estimation of theoretical minimum parts	Name of Assembly: Elbow
1	1	30	1.95	98	9.0	21.9	8.76	1	recovery tank
2	1	30	1.95	30	2	7.9	3.16	1	elbow pipe (w/ 90s, mount, clamps)
3	1	10	1.5	30	2	7	2.8	1	float
						36.8	14.72	3	Design Efficiency (%)
						Tm	Cm	Nm	24.45

Our original elbow design consists of an elbow placed on a mount and a float attached. The mount being bolted to the recovery tank using screws.

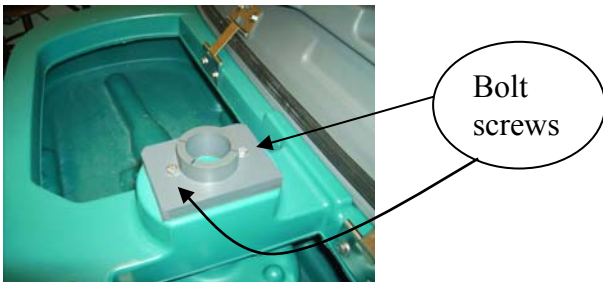

Figure 83 illustrates the elbow pipe mount connected to the recovery tank using bolt screws.



Figure 84 shows the recommended snap on bolt design

To change our assembly, we decided to join the mount and elbow pipe as one piece and use snap on bolts that don't requiring any turning but simply fit in to the holes by pushing on them. Using these ideas we performed a DFA analysis and determined that our assembly time has decreased by 58.6%, cost reduced by 37% and efficiency increased by 58.7%.

24.3 Material Selection and Design for Environment

Elbow Insulation

We compared melamine foam and polyurethane foam for the insulation of the elbow. From the results obtained in SimaPro, we observed that ecotoxicity is most likely to be important according to the graphs shown below. In most of the categories that impact the environment, polyurethane foam seems to have a greater effect than melamine foam. However, we chose polyurethane because CES showed that melamine foam was more costly and the uses of polyurethane were more pertinent to our application. In the long run, both melamine and polyurethane don't have an effect on ozone layer, ecotoxicity, and land use.

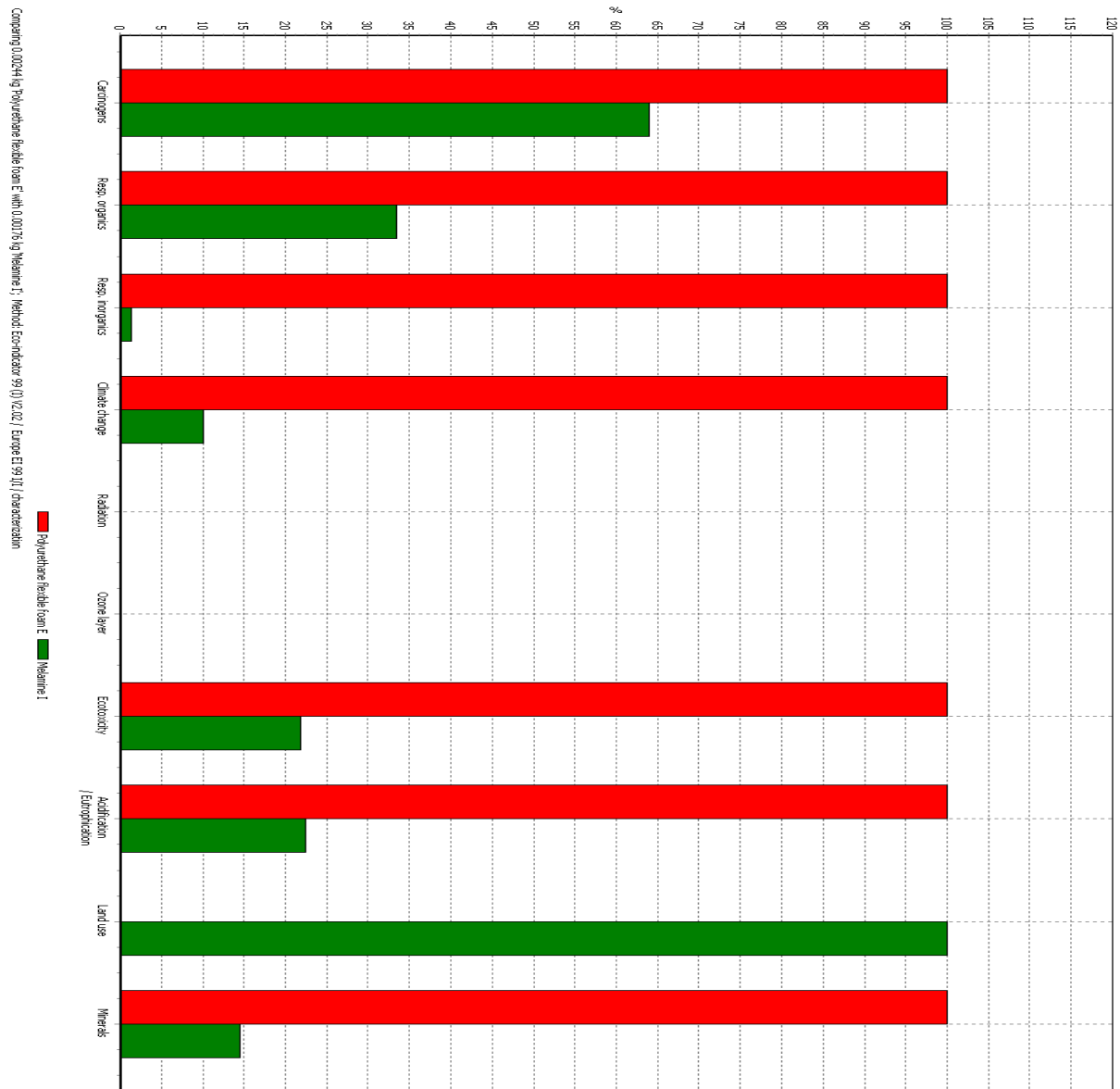

Figure 85 shows relative impacts in disaggregated damage categories

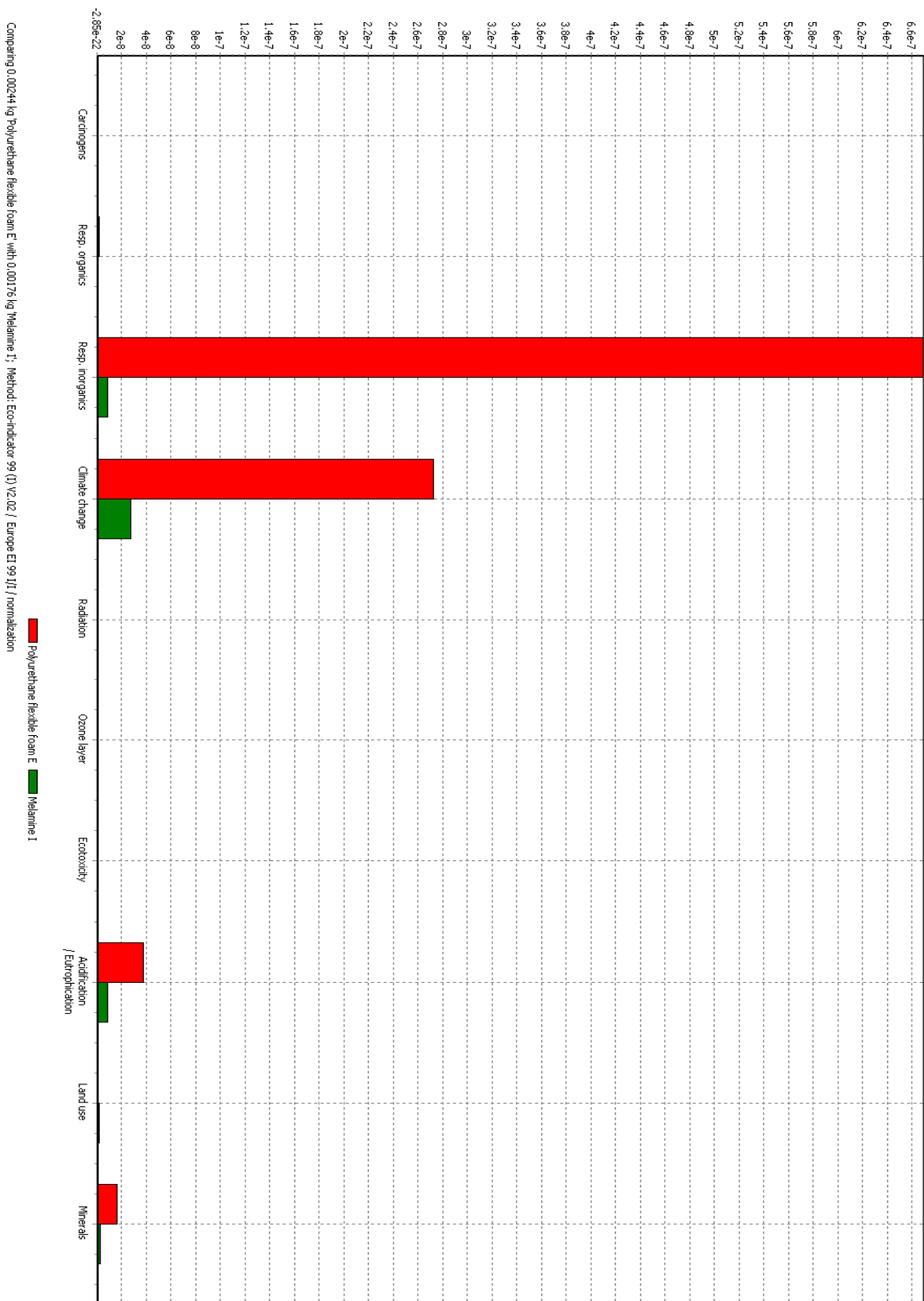

Figure 86 shows normalized score in human health, eco-toxicity and resource categories

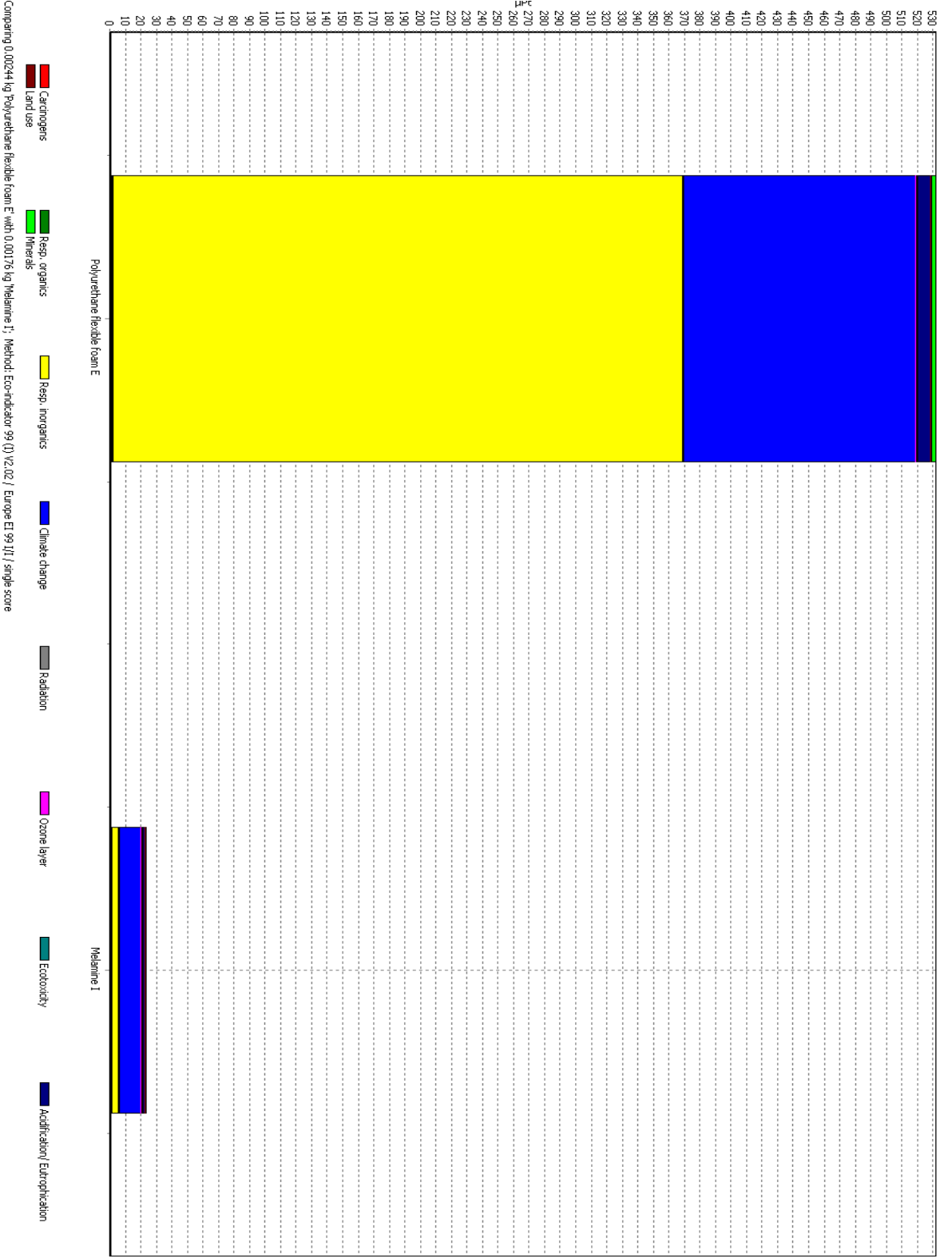

Figure 87 shows single score comparison in “points”

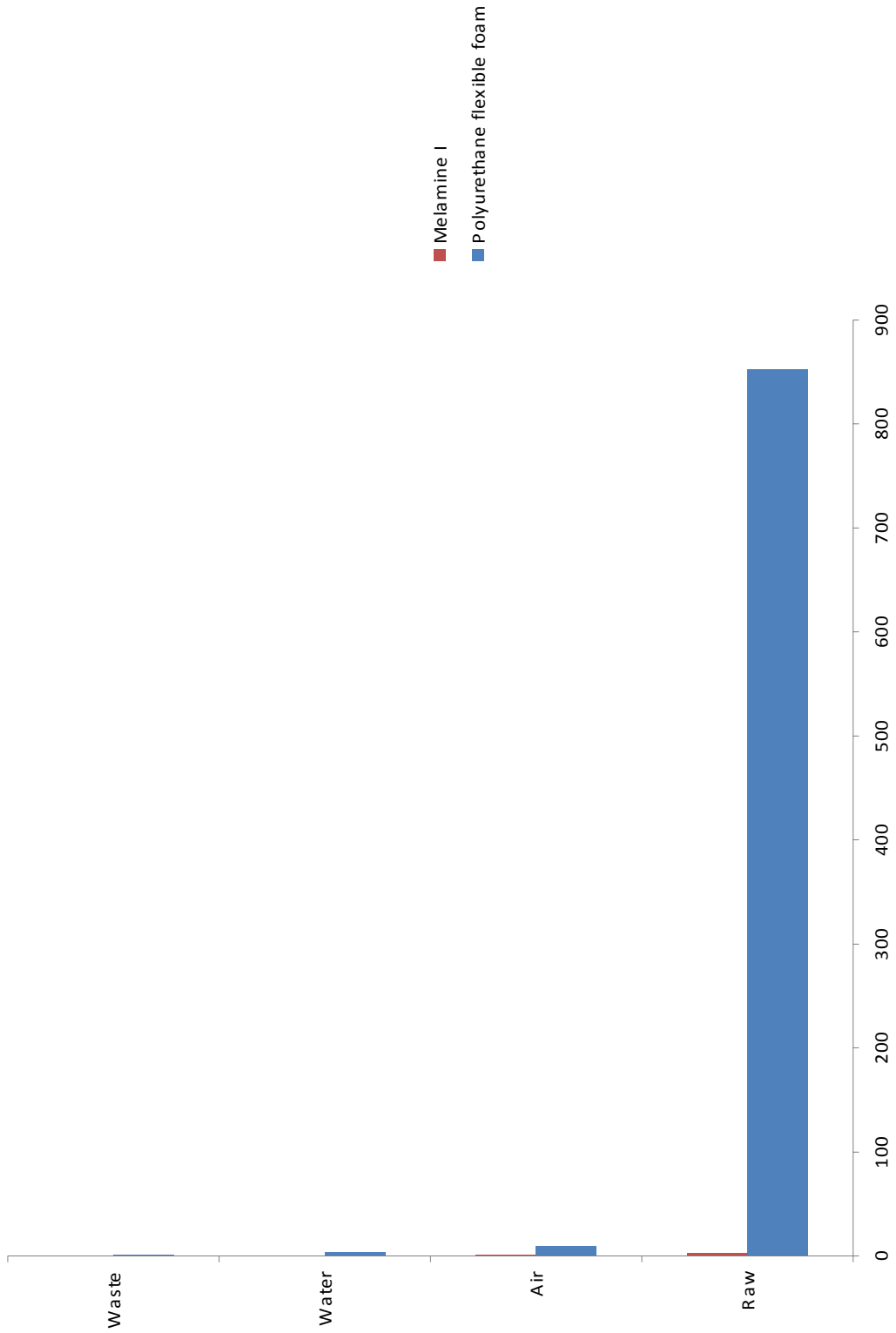

Figure 88 illustrates total emissions

Elbow Casing

For the casing of the elbow, we compared high density polyethylene and propylene. From our results, we observed that high density polyethylene has a lower impact on the environment than propylene. We would not consider using a different material after this analysis because polyethylene is used often for this application and it also has a better impact on the environment. In the long run, polyethylene has a lower impact on human health and ecosystem quality. Overall, the total emissions of polyethylene are significantly lower than propylene.

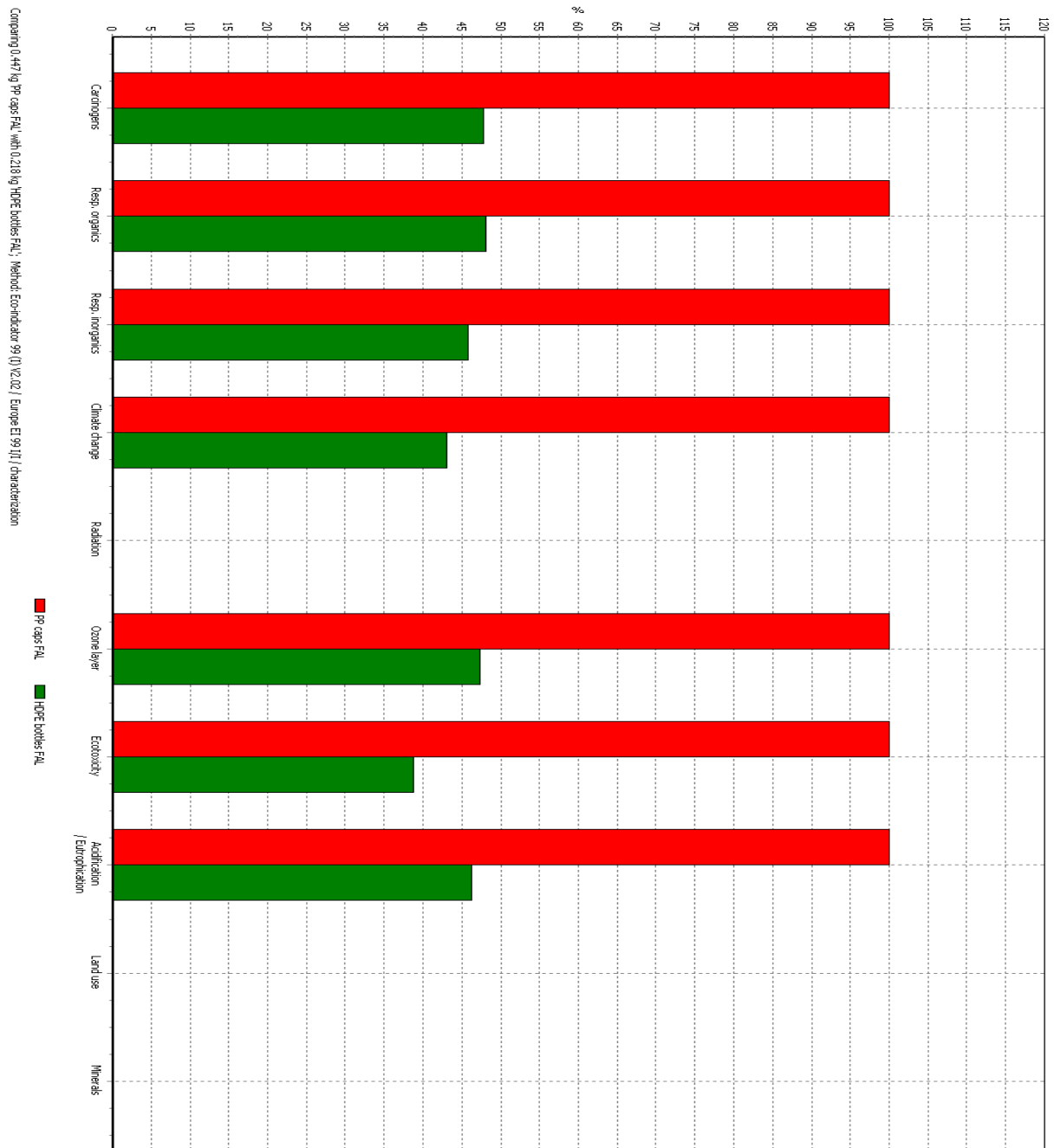

Figure 89 shows relative impacts in disaggregated damage categories

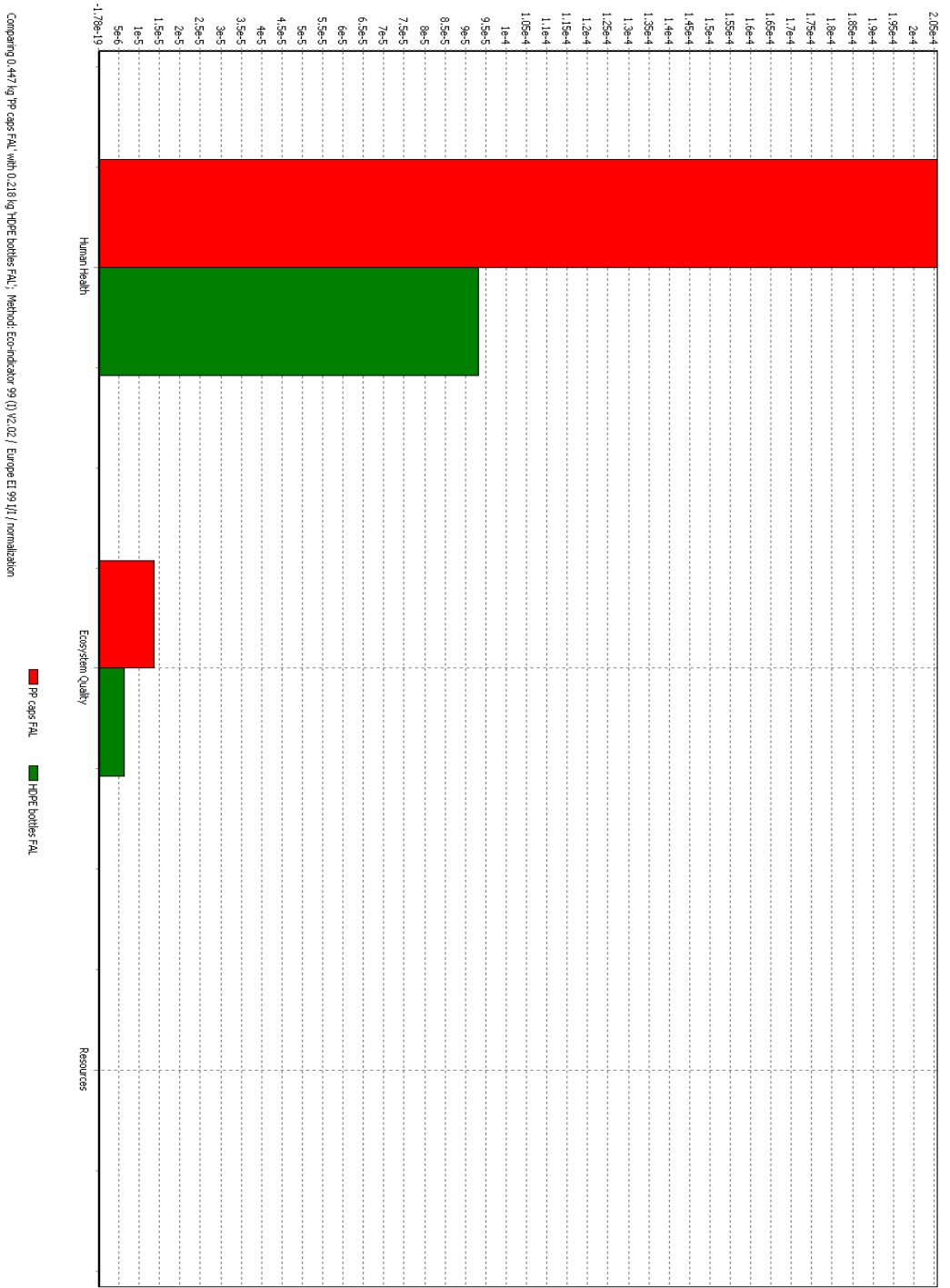

Figure 90 illustrate normalized score in human health, eco-toxicity and resource categories

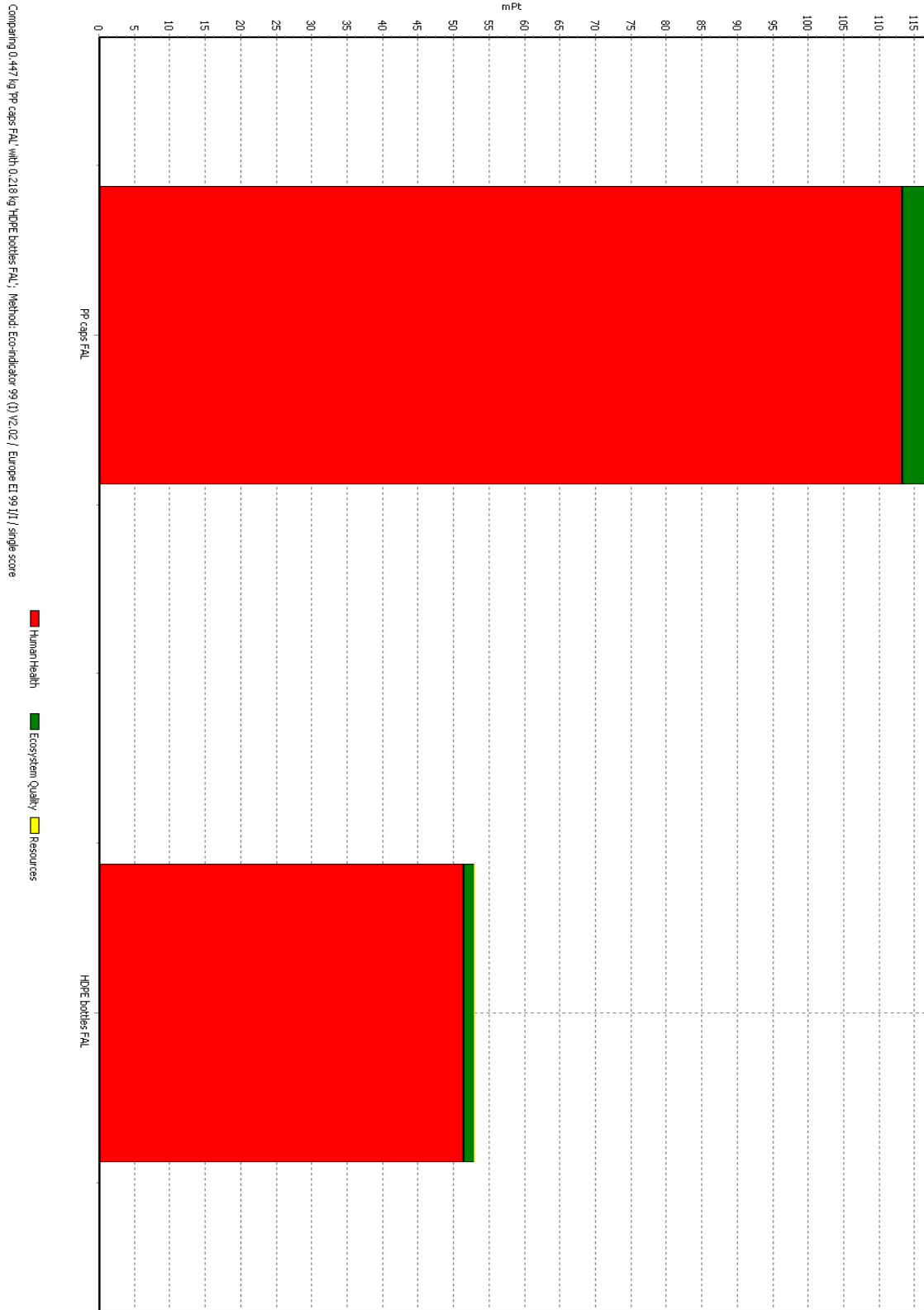

Figure 91 illustrates single score comparison in “points”

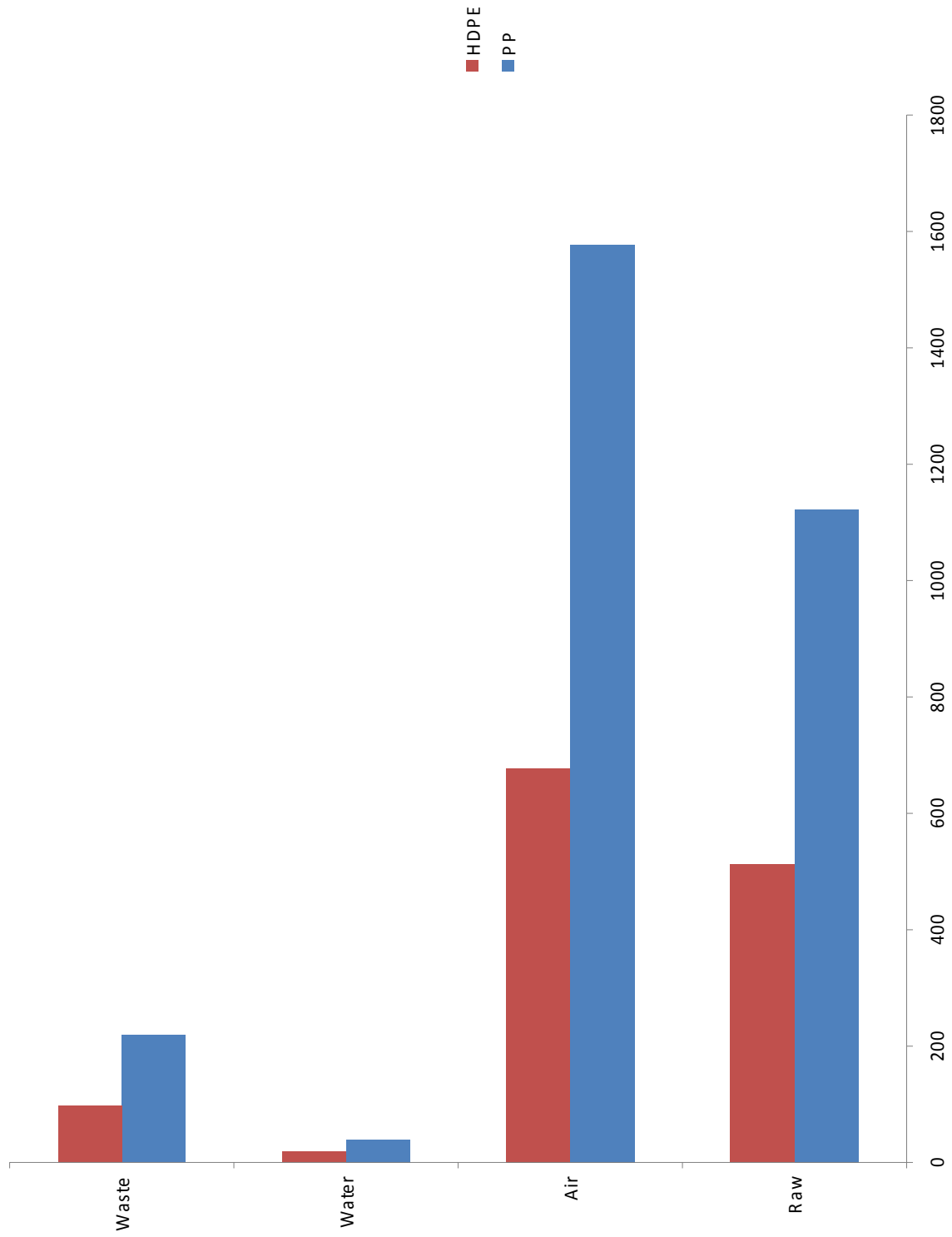

Figure 92 illustrates total emissions

24.4 Design for Safety

We performed a risk assessment on the Elbow pipe design using the software ‘designsafe’. It helped us determine the hazards associated with our design and to incorporate safety in our design. The table below summarizes the risks/hazards associated with the elbow pipe as well as the user who is at risk.

designsafe Report

Application: Elbow Pipe Analyst Name(s): Arsalan Ahmed
 Description: Company: Floor Scrubber
 Product Identifier: Facility Location:
 Assessment Type: Detailed
 Limits:
 Sources:

Guide sentence: When doing [task], the [user] could be injured by the [hazard] due to the [failure mode].

User / Task	Hazard / Failure Mode	Initial Assessment		Risk Reduction Methods /Comments	Final Assessment		Status / Responsible /Reference
		Severity Exposure Probability	Risk Level		Severity Exposure Probability	Risk Level	
All Users All Tasks	noise / vibration : noise / sound levels > 80 dBA Noise level at inlet 94 dBA	Serious Frequent Probable	High	hearing protection	Slight Occasional Unlikely	Moderate	
All Users All Tasks	noise / vibration : loss of hearing acuteness continued exposure to 85 dBA may cause gradual damage to hearing.	Serious Frequent Possible	High	hearing protection	Slight Occasional Unlikely	Moderate	
All Users All Tasks	noise / vibration : interference with communications a consistent noise level of 94 dBA is well above conversation level of 60 dBA	Slight Frequent Probable	High	other design change: redesign that reduces dBA level	Minimal Occasional Possible	Moderate	
All Users All Tasks	fluid / pressure : vacuum 0.75 hp vacuum motor provides strong suction	Slight Frequent Possible	High	E-stop control, other design change	Minimal Occasional Unlikely	Low	

Product Name: T5 Floor Scrubber			Development Team: __ Floor Scrubber Team _____				Page No. <u> 1 </u> of <u> 1 </u>						
System							FMEA Number: _____						
Subsystem Name: _____							Date: 4/15/08						
X Component													
Part # or Functions	Potential Failure Mode	Potential Effect(s) of Failure	Severity (S)	Potential Causes/Mechanism(s) of Failure	Occurrence (O)	Current Design Controls/Test	Detection (D)	Recommended Actions	RPN	New S	New O	New D	New RPN
Elbow pipe	Loose fitting, Acoustic noise, vibrations	increased vibrations, sound resonance, back pressure	5	assembly errors, dimensional errors, loose fittings, cracks	3	multiple runs	1	proper installation, tight fitting	15	4	1	1	4
Expansion Muffler	Loose fitting, Acoustic noise, vibrations	increased vibrations, sound resonance, back pressure	4	assembly errors, dimensional errors, loose fittings, cracks, high weight	3	multiple runs	1	proper installation, tight fitting	12	3	1	1	3
Elbow mount	loose Fitting, vibrations	increase noise	5	crack development, improper dimensions	4	multiple runs	2	ensure proper install	40	4	3	1	12
Fiberglass wool	wear	increase noise	3	excessive exposure to motor heat	5	multiple runs	3	measuring rise in temperature during multiple runs	45	3	4	2	24
Rubber Seal	sagging	increased noise	5	improper alignment, improper dimensioning	4	ensure seal strongly adheres to the body	2	ensure proper seal	40	4	3	1	12
Isolation Mounts	fatigue, material yield	increase vibrations, resonating motor noise	4	tight fitting, excessive load handling	6	multiple runs, ensure mounts are not too tightly fitted	4	proper installation	96	3	4	2	24

From design safe analysis we did not encounter any unexpected risk associated with the equipment, all risks were determined through multiple testing of the machine. The main difference between risk assessment and the FMEA is the impact on the user versus the machine due to failure. Risk assessment helps in determining how safe is the current system and how much safer do we need to make the system for usage. FMEA helps in identifying key failures and occurrence of failure in the system and determine actions to eliminate failure occurrence. By closely observing the risk assessment and FMEA of our design, there are a few risks/hazards that may be acceptable to a certain extent while with others there is no compromise. High noise level of about 80 dBA will be acceptable as long as the machine is being operated for a short period of time, however noise louder than 80 dBA could cause severe damage to hearing. Since the main function of our design is to control noise level high noise levels are unacceptable in every way. Small vibrations of the body would definitely effect that overall efficiency of the machine but it may not produce enormous noise but if the vibration causes resonance, not only does it severely affect the performance of the machine but it would also contribute to higher noise levels. Insulation of motor with fiberglass does help in reducing noise levels but overtime the fiberglass may deteriorate due to excessive motor heat which could damage the entire machine.

24.5 Manufacturing Process Selection

Floor scrubber is important equipment for cleaning purpose that is used worldwide. Since our project was to redesign some of the components for noise reduction, they are meaningless without the entire floor scrubber machine. We were successfully able to redesign and fabricate our prototype for design validation. The process was very rigorous and time consuming. If the same process were used to fabricate the actual design we would never be able to reach the production volume that we aim for. From our discussion with Mr. Fred Hekman we found out that Tennant Company manufactures floor scrubbers every day. Production of about 40-50 floor scrubbers is a reasonable estimate. Cleaning equipment is a necessity in all premises, whether they are hotels, hospitals or warehouses. Therefore we expect the production volume to increase in the future. In order to improve production efficiency and economic factor it is essential to select appropriate manufacturing processes for our design.

In order to determine the manufacturing process for the elbow pipe design, we used Cambridge engineering selector (CES). The exterior of the elbow pipe should be made from High density polyethylene and the inner insulation lining to be made from polyurethane foam. Through a systematic procedure we determined process by defining the shape, batch size, length, and many other quantities that are shown in the table below:

Shape	3D→Hollow→Transverse→Complex
Batch Size	50
Write off time (yrs)	5
Component Length (mm)	320
Component mass (kg)	0.68
Material Cost (\$/kg)	2.036
Overhead Rate (\$/hr)	110

Table 20 illustrates the physical attributes of the elbow pipe exterior

Applying these attributes we were able to determine that the most feasible process for the exterior elbow design is Injection molding. Researching various heat treatment processes and surface coatings we found that these processes are not applicable in our situation since we do not plan on having a metallic finish on our product.

For our insulation we chose to use polyurethane elastomeric foam open cell.

Shape	Prismatic→circular
Batch Size	50
Write off time (yrs)	5
Component Length (mm)	280
Component mass (kg)	0.20
Material Cost (\$/kg)	6.22
Overhead Rate (\$/hr)	110

Table 21 illustrates the physical attributes of the elbow pipe insulation

The process we decided to use is Polymer extrusion. Once the foam cell is manufactured, it can be attached to the inner walls of the elbow pipe using neoprene adhesive which was recommended by CES.

Since both the materials are being used in the same component and we plan on focusing only on the elbow pipe, there are two more materials that we recommend for the same component.
Insulation lining → Melamine foam

Shape	Prismatic→circular
Batch Size	50
Write off time (yrs)	5
Component Length (mm)	280
Component mass (kg)	0.10
Material Cost (\$/kg)	10.37
Overhead Rate (\$/hr)	110

Table 22 illustrates the physical attributes of the elbow pipe insulation

Recommended process would also be polymer extrusion.

Exterior → Polypropylene

Shape	3D→Hollow→Transverse→Complex
Batch Size	50
Write off time (yrs)	5
Component Length (mm)	320
Component mass (kg)	0.70
Material Cost (\$/kg)	1.52
Overhead Rate (\$/hr)	110

Table 23 illustrates the physical attributes of the elbow pipe exterior

The recommended process would be Rotational molding